



## INSTRUCTION MANUAL

VHF/UHF FM TRANSCEIVER

# IC-E91

Icom Inc.



---

## FOREWORD

---

Thank you for purchase of this fine Icom product. We understand you have a choice of many different radios in the market place. Many hours of research and development went into the design of your IC-E91, following Icom's philosophy of "technology first."

The IC-E91 VHF/UHF FM TRANSCEIVER is designed with Icom's superior technology and craftsmanship combining traditional analog technologies with the new digital D-STAR technologies for a balanced packaged.

With proper care, this product should provide you with years of trouble-free operation. We want to take a couple of moments of your time to thank you for making your IC-E91 your radio of choice, and hope you agree with Icom's philosophy of "technology first."

---

## EXPLICIT DEFINITIONS

---

WORD	DEFINITION
 <b>WARNING!</b>	Personal injury, fire hazard or electric shock may occur.
<b>CAUTION</b>	Equipment damage may occur.
<b>NOTE</b>	Recommended for optimum use. No risk of personal injury, fire or electric shock.

---

## FEATURES

---

- *DV mode (Digital voice + Low-speed data communication) operation is ready*
  - *GPS receiver connection*
  - *Text message and call sign exchange*(Optional UT-121 DIGITAL UNIT is required.)
- *Simple band scope*
- *Dualwatch operation*
- *Optional PC remote control*

---

## IMPORTANT

---

**READ ALL INSTRUCTIONS** carefully and completely before using the transceiver.

**SAVE THIS INSTRUCTION MANUAL**— This instruction manual contains important operating instructions for the IC-E91.

Icom, Icom Inc. and the ICOM logo are registered trademarks of Icom Incorporated (Japan) in the United States, the United Kingdom, Germany, France, Spain, Russia and/or other countries.

---

## PRECAUTIONS

---

**⚠ WARNING RF EXPOSURE!** This device emits Radio Frequency (RF) energy. Caution should be observed when operating this device. If you have any questions regarding RF exposure and safety standards please refer to the Federal Communications Commission Office of Engineering and Technology's report on Evaluating Compliance with FCC Guidelines for Human Radio Frequency Electromagnetic Fields (OET Bulletin 65)

**⚠ WARNING! NEVER** hold the transceiver so that the antenna is very close to, or touching exposed parts of the body, especially the face or eyes, while transmitting. The transceiver will perform best if the microphone is 5 to 10 cm away from the lips and the transceiver is vertical.

**⚠ WARNING! NEVER** operate the transceiver with a earphone, headphones or other audio accessories at high volume levels. Hearing experts advise against continuous high volume operation. If you experience a ringing in your ears, reduce the volume level or discontinue use.

**⚠ WARNING! NEVER** operate the transceiver while driving a vehicle. Safe driving requires your full attention—anything less may result in an accident.

**NEVER** connect the transceiver to a power source of more than 16 V DC. This will ruin the transceiver.

**NEVER** connect the transceiver to a power source using reverse polarity. This will ruin the transceiver.

**NEVER** expose the transceiver to rain, snow or any liquids. The transceiver may be damaged.

**NEVER** operate or touch the transceiver with wet hands. This may result in an electric shock or damage the transceiver.

**DO NOT** operate the transceiver near unshielded electrical blasting caps or in an explosive atmosphere.

**DO NOT** push the PTT when not actually desiring to transmit.

**BE CAREFUL!** The transceiver will become hot when operating it continuously for long periods.

**AVOID** using or placing the transceiver in direct sunlight or in areas with temperatures below  $-20^{\circ}\text{C}$  or above  $+60^{\circ}\text{C}$ .

Place the unit in a secure place to avoid inadvertent use by children.

**AVOID** the use of chemical agents such as benzine or alcohol when cleaning, as they can damage the transceiver's surfaces.

1

2

3

4

5

6

7

8

9

10

11

12

13

14

15

16

---

# TABLE OF CONTENTS

---

FOREWORD .....	i	5 BASIC OPERATION .....	20–28
EXPLICIT DEFINITIONS .....	i	■ Receiving .....	20
FEATURES .....	i	■ Setting audio volume .....	20
IMPORTANT .....	i	■ Setting squelch level .....	21
PRECAUTIONS .....	ii	■ Operating mode selection .....	21
TABLE OF CONTENTS .....	iii	■ Monitor function .....	22
SUPPLIED ACCESSORIES .....	v	■ Attenuator function .....	22
<b>1 ACCESSORY ATTACHMENT .....</b>	<b>1</b>	■ Band scope .....	23
■ Antenna .....	1	■ Transmitting .....	24
■ Belt clip .....	1	■ Transmit power selection .....	24
■ Handstrap .....	1	■ Lock function .....	25
■ Battery pack .....	1	■ Dualwatch operation .....	25
<b>2 PANEL DESCRIPTION .....</b>	<b>2–7</b>	■ TV channel operation .....	28
■ Front, top and side panels .....	2	<b>6 REPEATER AND DUPLEX OPERATIONS .....</b>	<b>29–33</b>
■ Function display .....	6	■ General .....	29
<b>3 BATTERY CHARGING .....</b>	<b>8–13</b>	■ Accessing a repeater .....	30
■ Caution .....	8	■ Duplex operation .....	32
■ Regular charging .....	10	■ 1750 Hz tone .....	33
■ Rapid charging .....	11	<b>7 DV MODE OPERATION .....</b>	<b>34–63</b>
■ Optional battery case .....	12	(Optional UT-121 is required) .....	
■ Battery information .....	12	■ Digital mode operation .....	34
■ External DC power operation .....	13	■ Call sign programming .....	34
<b>4 FREQUENCY AND CHANNEL SETTING .....</b>	<b>14–19</b>	■ Digital voice mode operation .....	38
■ Main band selection .....	14	■ About D-STAR system .....	40
■ Mode selection .....	15	■ Digital repeater operation .....	41
■ Operating band selection .....	16	■ Received call sign .....	46
■ Setting a tuning step .....	18	■ Copying the call sign .....	48
■ Setting a frequency .....	18	■ Break-in communication .....	51
		■ Message operation .....	52
		■ Automatic reply function .....	54

■ EMR communication .....	56	11 MENU SCREEN OPERATION .....	85–102
■ Low-speed data communication .....	56	■ General .....	85
■ GPS operation .....	58	■ MENU screen indication for B band .....	86
■ Other functions for DV mode operation .....	62	■ Menu list .....	86
<b>8 MEMORY/CALL CHANNELS .....</b>	<b>64–73</b>	■ Items list .....	86
■ General description .....	64	■ Set mode items .....	88
■ Selecting a memory channel .....	64	■ DV set mode items .....	92
■ Selecting a call channel .....	65	■ Scan set mode items .....	96
■ Memory channel programming .....	66	■ DUP/TONE set mode items .....	97
■ Memory bank setting .....	67	■ Display set mode items .....	99
■ Memory bank selection .....	68	■ Sounds set mode items .....	102
■ Programming memory/bank/scan name .....	69	<b>12 OTHER FUNCTIONS .....</b>	<b>103–117</b>
■ Selecting memory/bank name indication .....	70	■ Programming a DTMF code .....	103
■ Copying memory/call contents .....	71	■ Transmitting a DTMF code .....	104
■ Memory clearing .....	72	■ Clearing a DTMF memory .....	105
■ Erasing/transferring bank contents .....	73	■ Confirming a DTMF memory .....	105
<b>9 SCAN OPERATION .....</b>	<b>74–81</b>	■ Setting DTMF transfer speed .....	106
■ Scan types .....	74	■ Tone frequency and DTCS code .....	106
■ Full/band/programmed scan .....	75	■ Digital code and digital call sign setting .....	108
■ Scan edges programming .....	76	■ Tone/DTCS squelch .....	110
■ Memory scan .....	77	■ Digital code/digital call sign squelch .....	110
■ Memory bank scan .....	78	■ Pocket beep function .....	111
■ Skip channel/frequency setting .....	79	■ DTCS polarity setting .....	111
■ Scan resume condition .....	81	■ Tone scan .....	112
<b>10 PRIORITY WATCH .....</b>	<b>82–84</b>	■ Beep tones .....	113
■ Priority watch types .....	82	■ Dial speed acceleration .....	113
■ Priority watch operation .....	83	■ Key lock effect .....	113
		■ Power save .....	114
		■ Auto power OFF .....	114
		■ Auto power ON .....	114

■ Time-out timer .....	115
■ PTT lock .....	115
■ [MIC/SP] jacks .....	115
■ Cloning function .....	116
■ Resetting .....	117
<b>13 TROUBLESHOOTING .....</b>	<b>118</b>
<b>14 SPECIFICATIONS .....</b>	<b>119-120</b>
<b>15 OPTIONS .....</b>	<b>121-123</b>
■ Optional UT-121 installation .....	122
■ Optional HM-75A REMOTE CONTROL MICROPHONE .....	123
<b>16 CE .....</b>	<b>124-125</b>

## SUPPLIED ACCESSORIES

The following accessories are supplied with the transceiver.

① Hand strap .....	1
② Antenna .....	1
③ Battery pack* .....	1
④ Battery charger* .....	1
⑤ Belt clip (with screws) .....	1 set

\*Not supplied with some versions.

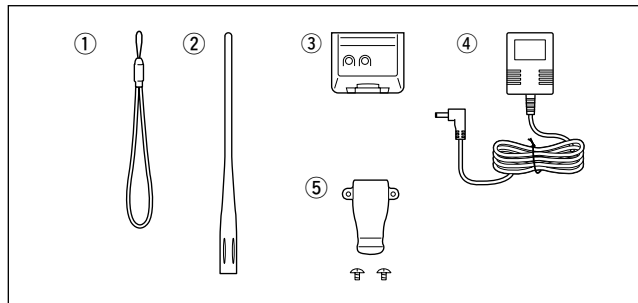

## ■ Antenna

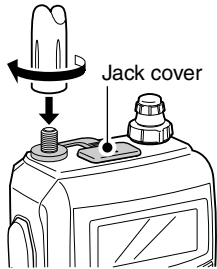

Insert the supplied antenna into the antenna connector and screw down the antenna as shown at left.

**NEVER** carry the transceiver by holding the antenna.

**KEEP** the jack cover attached when jack is not in use to protect the connector from dust and moisture.

### ✓ For your information

Third-party antennas may increase transceiver performance. An optional AD-92SMA ANTENNA CONNECTOR ADAPTER is available to connect an antenna with a BNC connector.

## ■ Belt clip

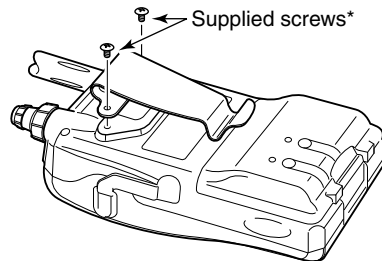

### \*NOTE:

**USE** the supplied screws only. Using screws longer than specified could damage the transceiver.

## ■ Handstrap

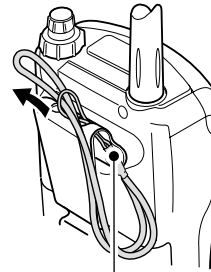

Handstrap

Slide the handstrap through the loop on the top of the belt clip as illustrated at left to facilitate carrying the transceiver.

## ■ Battery pack

Attach the Li-ion battery pack (BP-217) or battery case (BP-216) as illustrated below.

- Charge the Li-ion battery pack before use. (pgs. 10, 11)

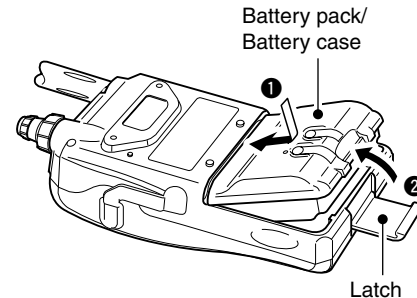

## ■ Front, top and side panels

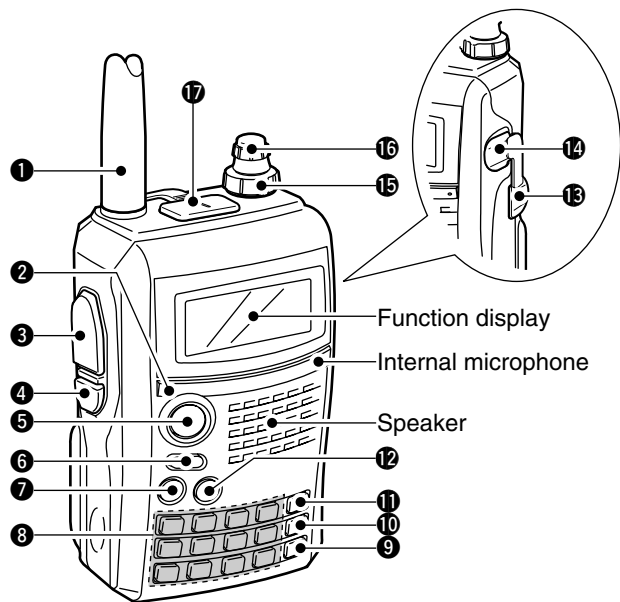

### ① ANTENNA CONNECTOR (p. 1)

Connects the supplied antenna.

- An optional AD-92SMA adapter (p. 121) is available for connecting an antenna with a BNC connector.

### ② TX/RX INDICATOR [TX/RX] (p. 24)

Lights green while receiving a signal or when the squelch is open; lights red while transmitting.

### ③ PTT SWITCH [PTT] (p. 24)

Push and hold to transmit, release to receive.

### ④ SQUELCH KEY [SQL]

- ➔ Push and hold to open the squelch temporarily and monitor the operating frequency. (p. 22)
- ➔ While pushing and holding this key, rotate [DIAL] to adjust the squelch level. (p. 21)

### ⑤ MENU/LOCK KEY [MENU/LOCK]

- ➔ Push to toggle menu screen indication ON and OFF. (p. 85)
- ➔ Push and hold for 1 sec. to toggle the lock function ON and OFF. (p. 25)

### ⑥ POWER KEY [PWR]

Push and hold for 1 sec. to turn the transceiver power ON and OFF.

### ⑦ MAIN/DUAL KEY [MAIN/DUAL]

- ➔ Push to select the main band between A and B bands. (p. 26)
- ➔ Push and hold for 1 sec. to toggle the dualwatch function ON and OFF. (p. 25)

### ⑧ KEYPAD (pgs. 4, 5)



**9 CALL/RX→CS KEY [CALL]/[RX→CS](CALL)**

- Push to select the call channel/TV channel. (p. 16)
- During DV mode operation, push and hold for 1 sec. to set the received call signs (station and repeaters) for operation. (p. 47)
- Enters or sends the DTMF code “C.” (pgs. 103, 104)

**10 MEMORY/SELECT MEMORY WRITE KEY [MR]/[S.MW](MR)**

- Push to select memory mode. (p. 15)
- During memory mode operation, push to toggle between memory and memory bank mode. (p. 68)
- Push and hold for 1 sec. to enter select memory write mode. (p. 64)
- Enters or sends the DTMF code “B.” (pgs. 103, 104)

**11 VFO/MHz KEY [VFO]/[MHz](VFO)**

- Push to toggle select VFO mode. (p. 15)
- During VFO mode operation, push and hold for 1 sec. to select and toggle 1 MHz and 10 MHz tuning steps (p. 18)
- Enters or sends the DTMF code “A.” (pgs. 103, 104)

**12 BAND KEY [BAND]**

- During VFO mode operation, push to select an operating frequency band. (pgs. 16, 17)
- During memory bank mode, push to select a memory bank. (p. 68)
- Enters or sends the DTMF code “D.” (pgs. 103, 104)

**13 EXTERNAL DC IN JACK [DC IN]**

- Connects the supplied wall charger, BC-167A/D, to charge the attached battery pack. (p. 10)
- Connect an external DC power supply through the optional CP-19R or OPC-254L for external DC operation. (p. 13)

**14 DATA JACK [DATA]**

- Connects a PC through the optional data communication cable, OPC-1529R, for low-speed data communication or control the transceiver remotely using the optional RS-91 (OPC-1529R is supplied). (p. 56)

**15 VOLUME CONTROL [VOL]**

- Rotate to adjust the audio output level. (p. 20)

**16 CONTROL DIAL [DIAL]**

- Rotate to tune the operating frequency. (p. 18)
- During memory mode, rotate to select the memory channel. (pgs. 15, 64)
- While pushing and holding [BAND], selects the operating band in VFO mode. (p. 18)
- While scanning, changes the scanning direction. (p. 75)
- While pushing and holding [SQL], sets the squelch level. (p. 21)
- While pushing and holding [BAND], selects the programmed bank in memory mode. (p. 68)







**17 EXTERNAL SPEAKER/MICROPHONE JACK [MIC/SP]**







- Connect an optional speaker-microphone or headset, if desired.

See page 121 for a list of available options.

## 2 PANEL DESCRIPTION

### ◆ KEYPAD

KEY	Pushed momentarily	Pushed and held for 1 sec.
	<ul style="list-style-type: none"> <li>• Inputs digit '1' for frequency input, memory channel selection, etc.</li> <li>• While pushing [PTT], this key sends the DTMF code "1."</li> </ul>	<ul style="list-style-type: none"> <li>• Displays the simple band scope for a single sweep. (p. 23)</li> </ul>
	<ul style="list-style-type: none"> <li>• Inputs digit '2' for frequency input, memory channel selection, etc.</li> <li>• While pushing [PTT], this key sends the DTMF code "2."</li> </ul>	<ul style="list-style-type: none"> <li>• Starts a scan. (p. 75)</li> </ul>
	<ul style="list-style-type: none"> <li>• Inputs digit '3' for frequency input, memory channel selection, etc.</li> <li>• While pushing [PTT], this key sends the DTMF code "3."</li> </ul>	<ul style="list-style-type: none"> <li>• Toggles the transmit output power between high and low. (p. 24) <ul style="list-style-type: none"> <li>- "LOW" appears when low power is selected.</li> <li>- While pushing and holding this key, with [DIAL] rotation selects the output power.</li> </ul> </li> </ul>
	<ul style="list-style-type: none"> <li>• Inputs digit '4' for frequency input, memory channel selection, etc.</li> <li>• While pushing [PTT], this key sends the DTMF code "4."</li> </ul>	<ul style="list-style-type: none"> <li>• Activates the following duplex functions in order. <ul style="list-style-type: none"> <li>- Minus duplex operation— "-DUP" appears.</li> <li>- Plus duplex operation— "+DUP" appears.</li> <li>- Simplex operation— no duplex indicator appears.</li> <li>- While pushing and holding this key, with [DIAL] rotation selects the duplex function.</li> </ul> </li> </ul>
	<ul style="list-style-type: none"> <li>• Inputs digit '5' for frequency input, memory channel selection, etc.</li> <li>• While pushing [PTT], this key sends the DTMF code "5."</li> </ul>	<ul style="list-style-type: none"> <li>• Turn the frequency skip function ON and OFF in VFO mode, or set the memory channel as the following skip channel in memory mode in order (p. 79). <ul style="list-style-type: none"> <li>- Skip channel— "SKIP" appears.</li> <li>- Frequency skip channel— "PSKIP" appears.</li> <li>- Non-skip channel— no skip indicator appears.</li> </ul> </li> </ul>
	<ul style="list-style-type: none"> <li>• Inputs digit '6' for frequency input, memory channel selection, etc.</li> <li>• While pushing [PTT], this key sends the DTMF code "6."</li> </ul>	<ul style="list-style-type: none"> <li>• Turn the memory name or bank name indication ON and OFF. (p. 70)</li> </ul>

KEY	Pushed momentarily	Pushed and held for 1 sec.
	<ul style="list-style-type: none"> <li>Inputs digit '7' for frequency input, memory channel selection, etc.</li> <li>While pushing [PTT], this key sends the DTMF code "7."</li> </ul>	<ul style="list-style-type: none"> <li>During FM/FM-N mode operation, selects repeater tone, tone squelch, DTCS squelch and no tone operation in sequence. (p. 110)</li> <li>During DV mode operation, selects digital call sign, digital code and no tone operation in sequence. (p. 110)</li> </ul>
	<ul style="list-style-type: none"> <li>Inputs digit '8' for frequency input, memory channel selection, etc.</li> <li>While pushing [PTT], this key sends the DTMF code "8."</li> </ul>	<ul style="list-style-type: none"> <li>Selects tuning step selection. (p. 18)</li> </ul>
	<ul style="list-style-type: none"> <li>Inputs digit '9' for frequency input, memory channel selection, etc.</li> <li>While pushing [PTT], this key sends the DTMF code "9."</li> </ul>	<ul style="list-style-type: none"> <li>During FM/FM-N mode operation, starts tone scan function. (p. 112)</li> <li>During DV mode operation, selects break-in operation mode. (p. 51)</li> </ul>
	<ul style="list-style-type: none"> <li>Inputs digit '0' for frequency input, memory channel selection, etc.</li> <li>While pushing [PTT], this key sends the DTMF code "0."</li> </ul>	<ul style="list-style-type: none"> <li>During DV mode operation, set "CQCQCQ" for station's call sign for operation.</li> </ul>
	<ul style="list-style-type: none"> <li>Inputs MHz digit for frequency input.</li> <li>While pushing [PTT], this key sends the DTMF code "F (#)."</li> </ul>	<ul style="list-style-type: none"> <li>Select DTMF memory mode. (p. 103)</li> <li>During DV mode operation, to turn EMR mode operation ON, keep pushing and holding until 3 short and 1 long beeps are emitted. (p. 56)</li> </ul>
	<ul style="list-style-type: none"> <li>During DV mode operation, selects the record track for voice memory. (p. 62)</li> <li>While pushing [PTT], this key sends the DTMF code "E (*)."</li> </ul>	<ul style="list-style-type: none"> <li>Selects the operating mode.</li> </ul>

### ■ Function display

#### • Single band indication

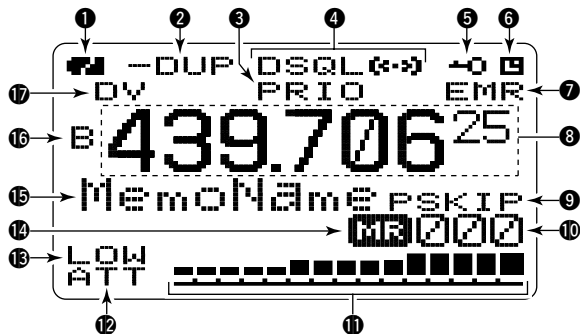

#### • Dualwatch indication

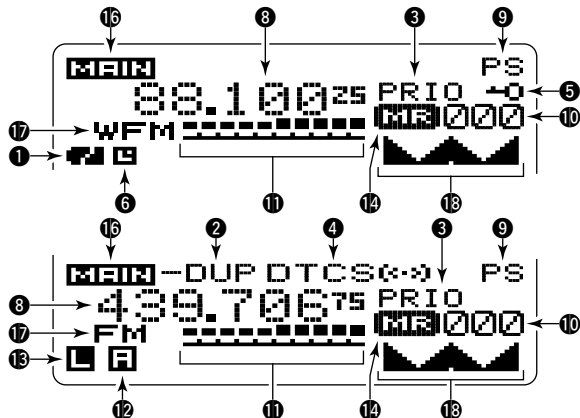

#### ① BATTERY INDICATOR (pgs. 10, 12)

- “” (battery indicators) appear when the Li-ion battery pack is attached.
- “” appears when the battery pack must be charged.
- The indicators show “,” “” and “” in sequence while charging the attached battery pack.

#### ② DUPLEX INDICATORS (p. 29)

- “+DUP” appears when plus duplex, “-DUP” appears when minus duplex is selected.

#### ③ PRIORITY WATCH INDICATOR (p. 83)

- Appears when priority watch is in use.

#### ④ TONE INDICATORS

##### • While operating in FM mode;

- “TONE” appears while the subaudible tone encoder is in use. (pgs. 29, 106)
- “TSQL” appears while the tone squelch function is in use. (p. 110)
- “DTCS” appears while the DTCS squelch function is in use. (p. 110)
- “((·))” appears with the “TSQL” or “DTCS” indicator while the pocket beep function (with CTCSS or DTCS) is in use. (p. 111)

##### • While operating in DV mode;

- “DSQL” appears while the call sign squelch function is in use. (p. 110)
- “CSQL” appears while the digital code squelch function is in use. (p. 110)

- ↳ “((•))” appears with the “DSQL” or “CSQL” indicator while the pocket beep function (with digital call sign or digital code squelch) is in use. (p. 111)
- 5 KEY LOCK INDICATOR** (pgs. 25, 113)  
Appears when the key lock function is activated.
- 6 AUTO POWER OFF INDICATOR** (p. 88)  
Appears when the auto power OFF function is in use.
- 7 EMR MODE INDICATOR** (p. 56)  
Appears when the EMR mode operation is selected.
- 8 FREQUENCY READOUT**  
Displays a variety of information, such as operating frequency, set mode contents, memory names.
  - The decimal point blinks during scan.
- 9 SKIP INDICATORS** (pgs. 79, 80)
  - ↳ “SKIP” appears when the selected memory channel is set as a skip channel.
  - ↳ “P SKIP” appears when the displayed frequency is set as a skip frequency.
- 10 MEMORY CHANNEL NUMBER INDICATOR**
  - ↳ Shows the selected memory channel number. (pgs. 64, 65)
  - ↳ “C” appears when the call channel is selected. (pgs. 16, 65)
  - ↳ “TV” appears when the TV channel is selected. (pgs. 16, 28)
- 11 S/RF METER**
  - ↳ Shows the relative signal strength while receiving signals.
  - ↳ Shows the output power level while transmitting. (p. 24)
- 12 ATTENUATOR INDICATOR** (p. 22)  
Appears when the RF attenuator is in use.
- 13 LOW POWER INDICATOR** (p. 24)
  - ↳ “LOW” appears when low power is selected.
  - ↳ No indicator appears when high power is selected.
- 14 MEMORY INDICATOR** (p. 64)  
Appears when memory mode is selected.
- 15 NAME INDICATOR** (p. 70)  
During memory mode operation, the programmed memory or memory bank name is displayed.
- 16 MAIN BAND INDICATOR** (p. 14)  
Shows which operating band, “A” or “B,” is selected for the main band.
- 17 OPERATING MODE INDICATOR** (p. 21)  
Shows the selected operating mode.
  - DV, FM, FM-N, WFM and AM are available, depending on operating band.
- 18 SIMPLE BAND SCOPE INDICATOR** (p. 23)  
When the simple band scope function is in use, shows the band conditions.

## ■ Caution

Misuse of Lithium-ion batteries may result in the following hazards: smoke, fire, or the battery may rupture. Misuse can also cause damage to the battery or degradation of battery performance.

- ⚠ **DANGER!** Use and charge only specified Icom battery packs with Icom radios. Only Icom battery packs are tested and approved for use with Icom radios. Using third-party or counterfeit battery packs may cause smoke, fire, or cause the battery to burst.

### ◆ Battery caution

- ⚠ **DANGER! DO NOT** hammer or otherwise impact the battery. Do not use the battery if it has been severely impacted or dropped, or if the battery has been subjected to heavy pressure. Battery damage may not be visible on the outside of the case. Even if the surface of the battery does not show cracks or any other damage, the cells inside the battery may rupture or catch fire.
  - ⚠ **DANGER! NEVER** use or leave battery pack in areas with temperatures above +60°C. High temperature buildup in the battery, such as could occur near fires or stoves, inside a sun heated car, or in direct sunlight may cause the battery to rupture or catch fire. Excessive temperatures may also degrade battery performance or shorten battery life.
- ⚠ **DANGER! DO NOT** expose the battery to rain, snow, seawater, or any other liquids. Do not charge or use a wet battery. If the battery gets wet, be sure to wipe it dry before using. The battery is not waterproof.
  - ⚠ **DANGER! NEVER** incinerate an used battery pack since internal battery gas may cause it to rupture, or may cause an explosion.
  - ⚠ **DANGER! NEVER** solder the battery terminals, or **NEVER** modify the battery pack. This may cause heat generation, and the battery may burst, emit smoke or catch fire.
  - ⚠ **DANGER!** Use the battery only with the transceiver for which it is specified. Never use a battery with any other equipment, or for any purpose that is not specified in this instruction manual.
  - ⚠ **DANGER!** If fluid from inside the battery gets in your eyes, blindness can result. Rinse your eyes with clean water, without rubbing them, and see a doctor immediately.
  - **WARNING!** Immediately stop using the battery if it emits an abnormal odor, heats up, or is discolored or deformed. If any of these conditions occur, contact your Icom dealer or distributor.
  - **WARNING!** Immediately wash, using clean water, any part of the body that comes into contact with fluid from inside the battery.

- **WARNING! NEVER** put the battery in a microwave oven, high-pressure container, or in an induction heating cooker. This could cause a fire, overheating, or cause the battery to rupture.
- **CAUTION!** Always use the battery within the specified temperature range,  $-20^{\circ}\text{C}$  to  $+60^{\circ}\text{C}$ . Using the battery out of its specified temperature range will reduce the battery's performance and battery life.
- **CAUTION!** Shorter battery life could occur if the battery is left fully charged, completely discharged, or in an excessive temperature environment (above  $+50^{\circ}\text{C}$ ) for an extended period of time. If the battery must be left unused for a long time, it must be detached from the radio after discharging. You may use the battery until the battery indicator shows half-capacity, then keep it safely in a cool dry place with the temperature between  $-20^{\circ}\text{C}$  to  $+20^{\circ}\text{C}$ .

#### ◇ Charging caution

- **⚠ DANGER! NEVER** charge the battery pack in areas with extremely high temperatures, such as near fires or stoves, inside a sun heated car, or in direct sunlight. In such environments, the safety/protection circuit in the battery will activate, causing the battery to stop charging.
- **WARNING! DO NOT** charge or leave the battery in the battery charger beyond the specified time for charging. If the battery is not completely charged by the specified time, stop charging and remove the battery from the battery charger. Continuing to charge the battery beyond the specified time limit may cause a fire, overheating, or the battery may rupture.
- **WARNING! NEVER** insert the transceiver (battery attached to the transceiver) into the charger if it is wet or soiled. This could corrode the battery charger terminals or damage the charger. The charger is not waterproof.
- **CAUTION! DO NOT** charge the battery outside of the specified temperature range:  $0^{\circ}\text{C}$  to  $+35^{\circ}\text{C}$ . Icom recommends charging the battery at  $+20^{\circ}\text{C}$ . The battery may heat up or rupture if charged out of the specified temperature range. Additionally, battery performance or battery life may be reduced.

## 3 BATTERY CHARGING

### ■ Regular charging

Prior to using the transceiver for the first time, the battery pack must be fully charged for optimum life and operation.

#### ◇ Battery indicators

The indicators show “”, “” and “” in sequence while charging, and both indicators disappear when completely charged.

#### ◇ Charging note

- Be sure to turn the transceiver power OFF. Otherwise the battery pack will not be charged completely or takes longer charging time periods.
- External DC power operation becomes possible when using an optional CP-19R or OPC-254L. The attached battery pack is also charged simultaneously, except during transmit. (see p. 11 for more details)
- The external DC power supply voltage must be within 10–16 V to charge the battery pack and operation when using an optional OPC-254L.

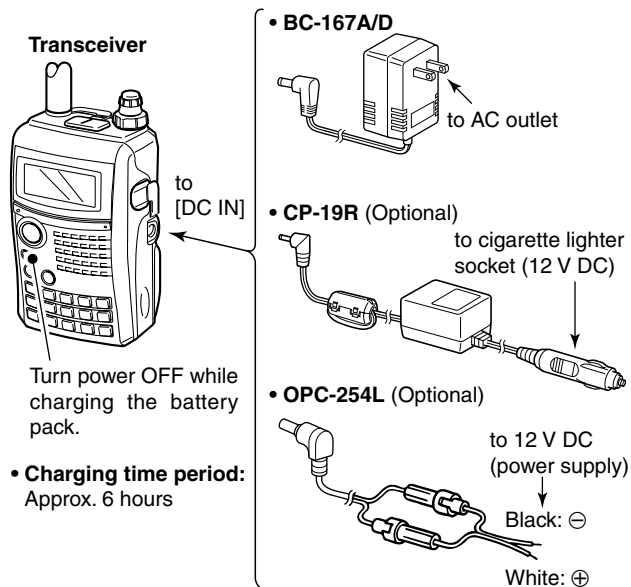



## ■ Rapid charging

The optional BC-139 provides rapid charging of the battery pack.

- **Charging period:** 2.5 hours (with BP-217)

### ◇ Charging note

- Be sure to turn the transceiver power OFF. Detach the battery pack from the transceiver then charge the battery pack by itself, or charge the battery with regular charging when the transceiver power cannot be turned OFF. Otherwise the battery pack will not be charged (charging indicator on the BC-139 blinks orange).
- The desktop charger, BC-139, can only be charged BP-217. Other types of rechargeable battery, Ni-Cd or Ni-MH, cannot be charged.
- If the charging indicator blinks orange, there may be a problem with the battery pack (or charger). Reinsert the battery pack or contact your dealer.
- The optional CP-19R and OPC-254L can be used instead of the supplied AC adapter (BC-123). Connect one of these to the [AC ADAPTER] jack in this case.

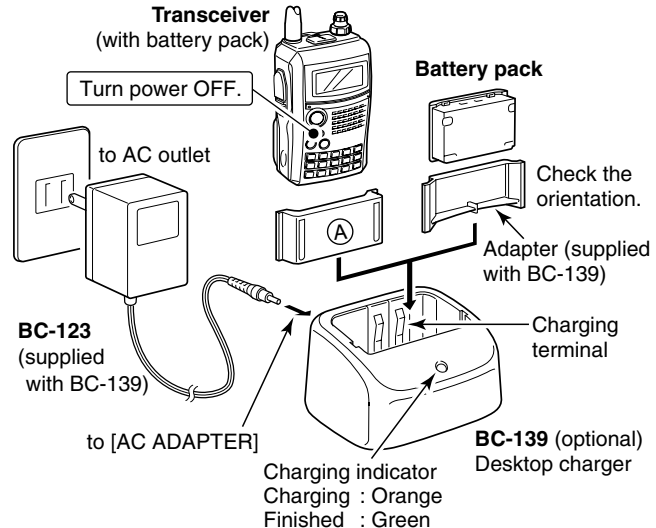

### 3 BATTERY CHARGING

#### ■ Optional battery case

➔ Install 2 R6 (AA) size alkaline batteries into the optional BP-216 BATTERY CASE.

- Be sure to observe the correct polarity.

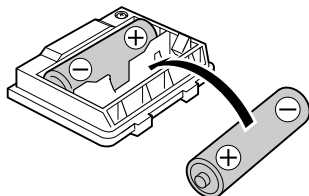

/// A built-in step-up converter in the BP-216 increases the voltage to 5 V DC.

/// Approx. 100 mW of output power is possible with the BP-216 operation. Also, no transmit output power selection is available.

/// Keep battery contacts clean. It's a good idea to clean battery terminals once a week.

#### ◇ Battery information

The batteries may seem to have low capacity when used in low temperatures such as  $-10^{\circ}\text{C}$  or below. Keep the battery case or pack warm in this case.

#### ◇ Battery replacement

When the batteries become exhausted, the function display may blink or have a lower contrast. In these cases, replace all batteries with new, same brand, alkaline batteries.

#### ■ Battery information

##### ◇ Battery life

The transceiver operates with the BP-217 as follows.

However, when operating in DV mode, operating time may be shortened by one-half hour.

- **VHF band** : Approx. 5 hours
- **UHF band** : Approx. 4.5 hours



(Tx: Rx: Stand-by=1: 1: 8)

/// Even when the transceiver power is OFF, a slight current still flows in the circuits. Remove the battery pack or case from the transceiver when not using it for a long time. Otherwise, the battery pack or installed batteries will become exhausted.

##### ◇ Battery indicator

The battery indicator, “,” appears only when the BP-217 is attached to the transceiver.

/// The battery indicator does not appear when turning power ON after the charging is completed without disconnecting the battery charger or external DC power.

Indication	Battery condition
	The battery has ample capacity.
	The battery is nearing exhaustion. Charging is necessary.

## External DC power operation

An optional cigarette lighter cable CP-19R; for 12 V cigarette lighter socket) or external DC power cable (OPC-254L) can be used for external power operation.

### Operating note

- Power supply range is between **10.0–16.0 V DC**. **NEVER CONNECT OVER 16 V DC** directly into the [DC IN] jack of the transceiver.
- **BE SURE** to use **CP-19R** or **OPC-254L** when connecting a regulated 12 V DC power supply.
- Use an external DC-DC converter to connect the transceiver through optional CP-19R or OPC-254L to a 24 V DC power source.
- The voltage of the external power supply must be within 10–16 V DC when using either CP-19R or OPC-254L, otherwise, use the battery pack.
- Up to 5 W (approx.) of maximum output power is provided with the external DC power operation, however, when the supplied voltage exceeds 14 V, the built-in protection circuit activates to reduce the transmit output power to 0.5 W (approx.).
- Disconnect the power cables from the transceiver when not using it. Otherwise, the vehicle battery will become exhausted.
- The power save function is deactivated automatically during external DC power operation.

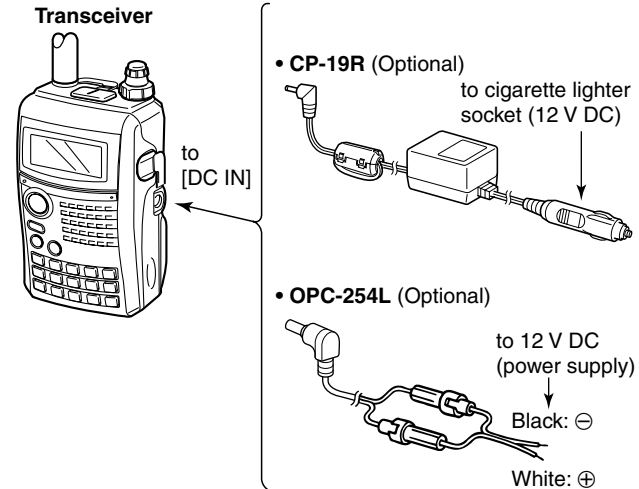

## ■ Main band selection

The IC-E91 has two independent operating bands; A band (VFO A) and B band (VFO B). A band (VFO A) can operate 0.495 MHz to 999.990 MHz\*, and B band (VFO B) can operate 118 MHz to 174 MHz\* and 350 MHz to 470 MHz\*.

\*Some frequency ranges are blocked according to transceiver version.

**NOTE:** When in dualwatch mode, transmission is available from the MAIN band only.

### ◇ How to change the main band

- ➔ Push **[MAIN/DUAL]** to toggle between A and B band.
- ➔ Push and hold **[MAIN/DUAL]** for 1 sec. to turn the dualwatch operation ON and OFF.
  - While in dualwatch operation, the display indicates A band in the upper half and B band in the lower half.
- ➔ During dualwatch operation, push **[MAIN/DUAL]** to select A band or B band as the main operating band alternately.

#### Single band operation

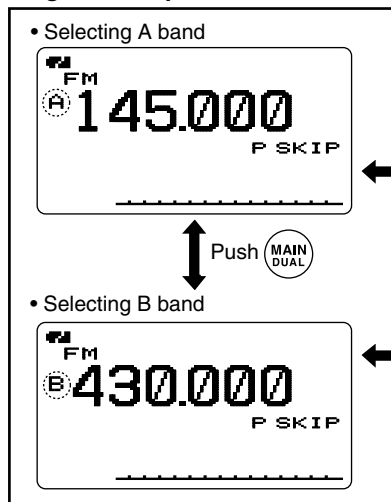

#### Dualwatch operation

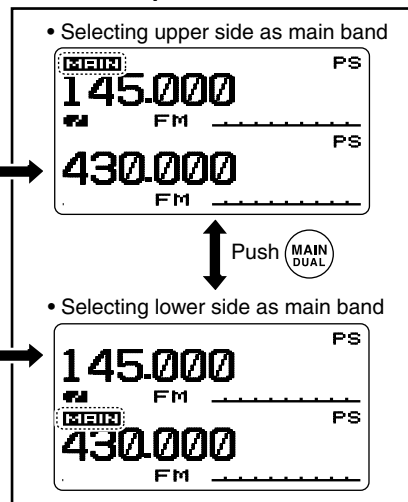

Push  
**[MAIN/DUAL]**  
for 1 sec.

## ■ Mode selection

### ◇ VFO mode

VFO mode is used to set the desired frequency.

➔ Push **[VFO]** to select VFO mode.

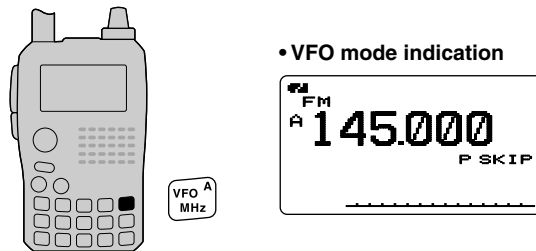

#### **What is VFO?**

VFO is an abbreviation of Variable Frequency Oscillator. Frequencies for both transmitting and receiving are generated and controlled by the VFO.

### ◇ Memory mode

Memory mode is used for operation on memory channels which store programmed frequencies.

- ① Push **[MR]** to select memory mode.
  - “**MR**” appears when memory mode is selected.

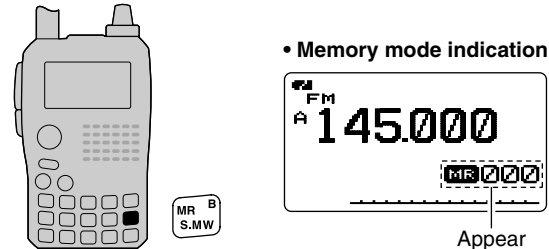

- ② Rotate **[DIAL]** to select the desired memory channel.
  - Only programmed memory channels can be selected.
  - Enter the memory channel directly to select the desired memory channel. (p. 64)
  - See p. 66 for memory programming details.

## 4 FREQUENCY AND CHANNEL SETTING

### ◇ Call/TV\* channels

Call channels are used for quick recall of most-often used frequencies.

/// \*Appears only when TV channels are programmed via the optional RS-91. Also available for A band operation only.

- ① Push **[CALL]** several times to select call channels/TV channels (A band only).
  - Call/TV channels can be selected in sequence.
- ② Rotate **[DIAL]** to select the desired channel.

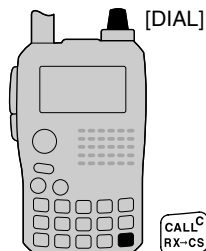

#### • Call channel indication

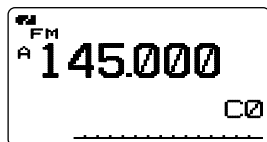

#### • TV channel indication

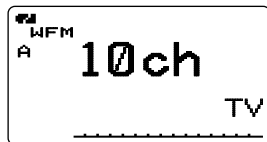

### ■ Operating band selection

The transceiver can receive the AM broadcast, HF bands, 50 MHz, FM broadcast, VHF air, 144 MHz, 300 MHz, 400 MHz or 800 MHz\* bands. (Some bands are not selectable for B band operation. See next page for details.)

- ➔ In VFO mode, push **[BAND]** several times to select the desired frequency band.
  - If the other than VFO mode is selected, such as a memory channel/call channel/TV channel, push **[VFO]** to select VFO mode first, then push **[BAND]** to select the desired band.
- ➔ While pushing and holding **[BAND]**, rotating **[DIAL]** also selects frequency band.

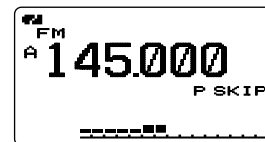
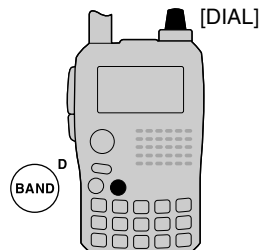

/// Available frequency bands are different depending on version. See the specification for details. (pgs. 119, 120)

/// \*Some frequency ranges are blocked according to transceiver version.

• Available frequency bands

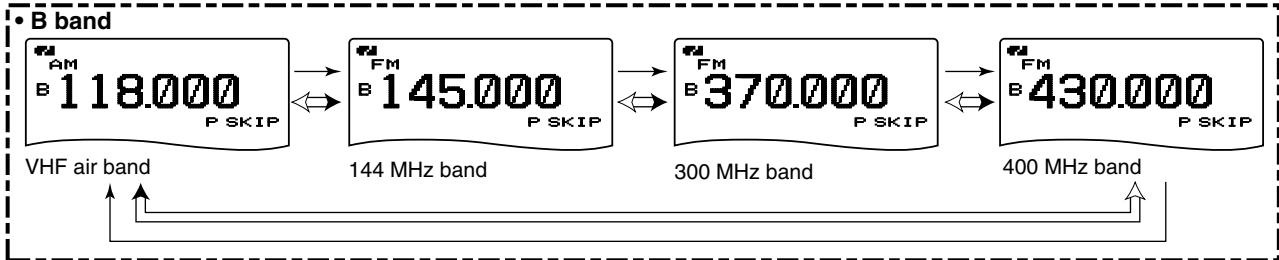
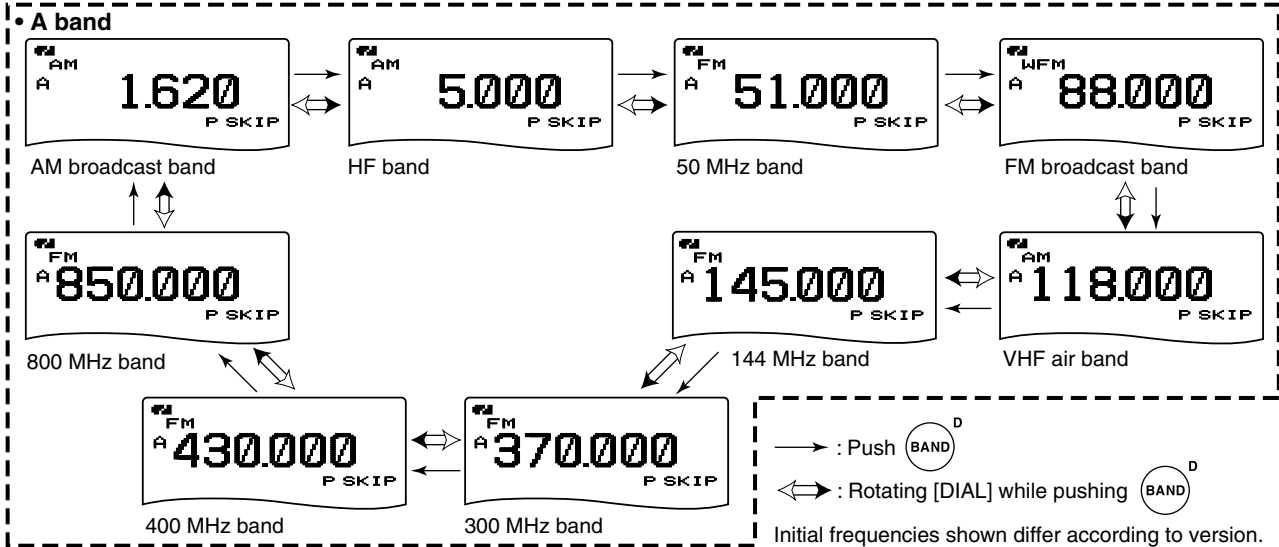

## 4 FREQUENCY AND CHANNEL SETTING

### ■ Setting a tuning step

The tuning step can be selected for each frequency band. The following tuning steps are available for the IC-E91.

- 5.0 kHz\* • 6.25 kHz\* • 8.33 kHz† • 9.0 kHz‡ • 10.0 kHz
- 12.5 kHz • 15.0 kHz • 20.0 kHz • 25.0 kHz • 30.0 kHz
- 50.0 kHz • 100.0 kHz • 125.0 kHz • 200.0 kHz

\* Appears for below the 600 MHz bands only.

† Appears for the VHF air band only.

‡ Appears for the AM broadcast band only.

#### ◇ Tuning step selection

- ① Push **[VFO]** to select VFO mode, if necessary.
- ② Push **[BAND]** to select the desired frequency band.
  - Or, while pushing and holding **[BAND]**, rotate **[DIAL]** to select the desired frequency band.
- ③ Push and hold **[TS](8)** for 1 sec. to enter tuning step set mode.
- ④ Rotate **[DIAL]** to select the desired tuning step.
- ⑤ Push **[TS](8)** (or **[VFO]**) to return to VFO mode.

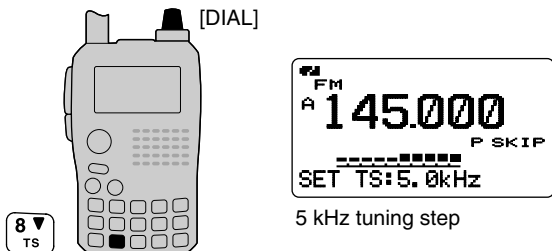

### ■ Setting a frequency

#### ◇ Using the dial

- ① Push **[VFO]** to select VFO mode, if necessary.
- ② Select the desired frequency band with **[BAND]**.
  - Or, while pushing and holding **[BAND]**, rotate **[DIAL]** to select the desired frequency band.
- ③ Rotate **[DIAL]** to select the desired frequency.
  - The frequency changes according to the preset tuning steps. See the left-hand side of the page to set the tuning step.
  - Push and hold **[MHz](VFO)** for 1 sec. then rotate **[DIAL]** to change the frequency in 1 MHz steps, or push and hold for 1 sec. again then rotate **[DIAL]** to change the frequency in 10 MHz steps. (Each pushing and holding for 1 sec. toggles 1 MHz or 10 MHz tuning steps. Push **[MHz](VFO)** to cancel it.)

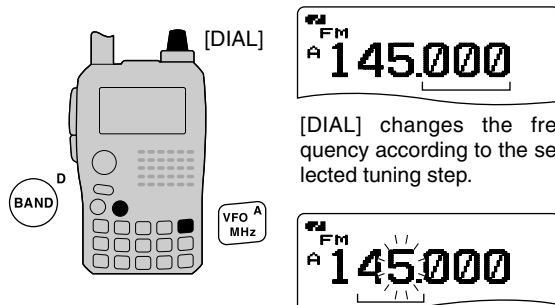

After pushing and holding **[MHz](VFO)** for 1 sec., **[DIAL]** changes the frequency in 1 MHz/10 MHz steps.



◆ Using the keypad

The frequency can be directly set via numeric keys.

- If a frequency outside the frequency range is entered, the previously displayed frequency is automatically recalled after editing last digit.

- ① Push [VFO] to select VFO mode, if necessary.
- ② Enter the desired frequency via the keypad.

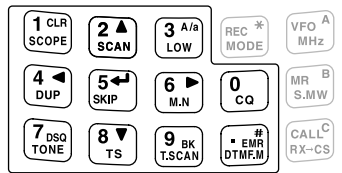

Depending on the tuning step setting, the 1 kHz digit may not be acceptable as input. In this case, enter "0" as 1 kHz digit, then rotate [DIAL] to set the desired frequency.

• Entering 145.520 MHz

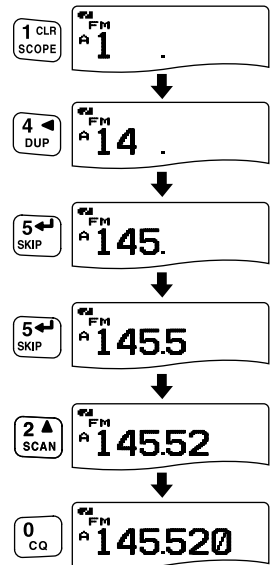

• Entering 79.3 MHz

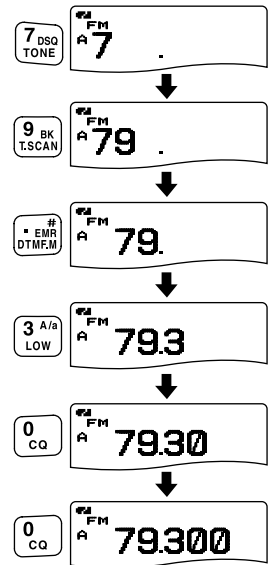

• Changing 100 kHz and below.

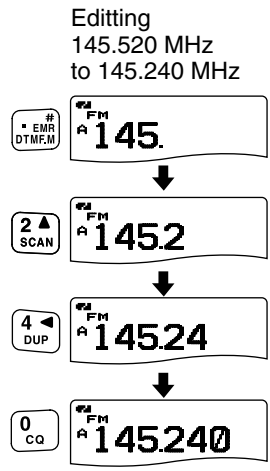

• Editing to 684 kHz

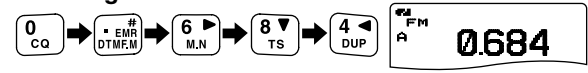

## ■ Receiving

Make sure charged battery pack (BP-217) or brand new alkaline batteries (BP-216) are installed (pgs. 1, 12).

- ① Push and hold **[PWR]** for 1 sec. to turn power ON.
- ② Rotate **[VOL]** to set the desired audio level.
  - The frequency display shows the volume level while setting. See the section at right for details.
- ③ Set the receiving frequency. (p. 18)
- ④ Set the squelch level. (p. 21)
  - While pushing and holding **[SQL]**, rotate **[DIAL]**.
  - The first click of **[DIAL]** indicates the current squelch level.
  - “LEVEL 1” is loose squelch (for weak signals) and “LEVEL 9” is tight squelch (for strong signals).
  - “AUTO” indicates automatic level adjustment by a noise pulse counting system.
  - Push and hold **[SQL]** to open the squelch manually.
- ⑤ When a signal is received:
  - Squelch opens and audio is output.
  - The S/RF-meter shows the relative signal strength level.

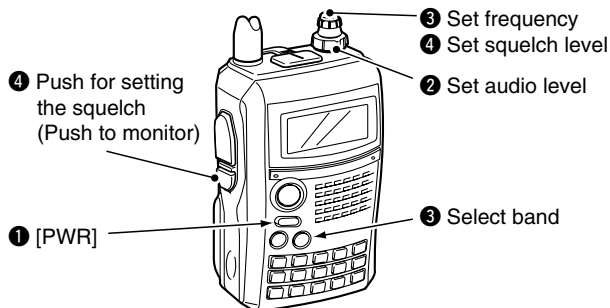

## ■ Setting audio volume

- Rotate **[VOL]** to adjust the audio level.
  - If squelch is closed, push and hold **[SQL]** to verify the audio level.
  - The display shows the volume level while setting.

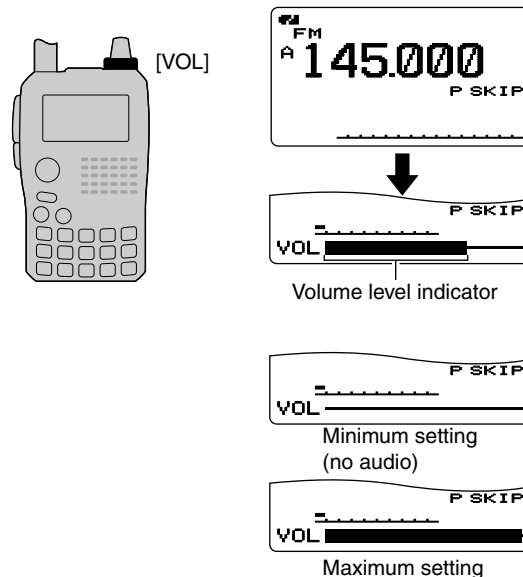

## ■ Setting squelch level

The squelch circuit mutes the received audio signal depending on the signal strength. The receiver has 9 squelch levels, a continuously open setting and an automatic squelch setting.

- ➔ While pushing and holding [SQL], rotate [DIAL] to select the squelch level.
  - “LEVEL 1” is loose squelch (for weak signals) and “LEVEL 9” is tight squelch (for strong signals).
  - “AUTO” indicates automatic level adjustment by a noise pulse counting system.
  - “OPEN” indicates continuously open setting.

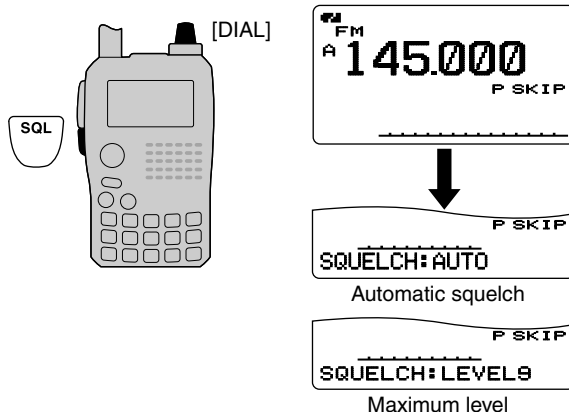

## ■ Operating mode selection

Operating modes are determined by the modulation of the radio signals. The transceiver has total 5 operating modes (A band: FM, WFM and AM modes, B band FM, FM-N, AM and DV modes). The mode selection is stored independently for each band and memory channel.

Typically, AM mode is used for the AM broadcast stations (0.495–1.620 MHz) and air band (118–136.995 MHz), and WFM is used for FM broadcast stations (76–107.9 MHz).

- ➔ Push and hold [MODE](REC) for 1 sec. several times to select the desired operating mode.

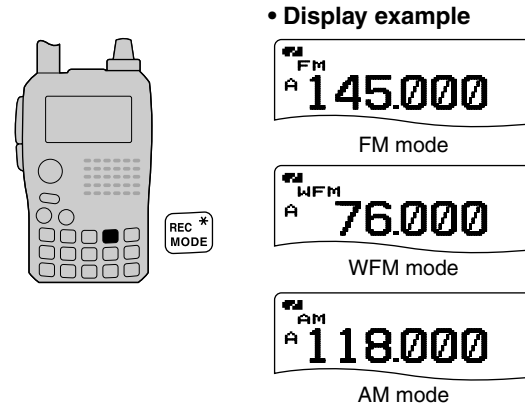

## ■ Monitor function

This function is used to listen to weak signals without disturbing the squelch setting or to open the squelch manually even when mute functions such as the tone squelch are in use.

- ➔ Push and hold **[SQL]** to monitor the operating frequency.
  - The 1st segment of the S-meter blinks.

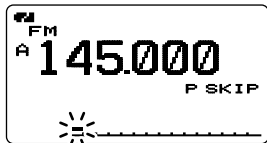

The 1st segment blinks

- ▨ The **[SQL]** key can be set to 'sticky' operation in set mode.
- ▨ See page 89 for details.

## ■ Attenuator function

The attenuator prevents a desired signal from distortion by very strong signals near the desired frequency or when very strong electric fields, such as from a broadcasting station, are near your location. The attenuation is about 10 dB.

- ① Enter "ATTENUATOR" in set mode. (p. 88)

◀MENU screen▶ ↔ ▶SET MODE▶ ↔ ▶ATTENUATOR▶  
 (Push **[MENU/LOCK]**) (Rotate **[DIAL]**†, then push **[↵](5)**†.)

- ② Rotate **[DIAL]**† to select "ON" or "OFF."
- ③ Push **[↵](5)** (or **[◀](4)**) to return to set mode, and push **[MENU/LOCK]** to return to frequency indication.
  - "ATT" appears on the function display when "ON" is selected.

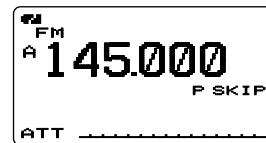
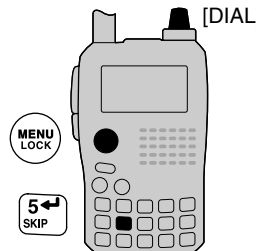

Appears.

†[DIAL] ↔ [▲](2)/[▼](8)

[↵](5) ↔ [▶](6)

## ■ Band scope

The band scope function allows you to visually check a specified frequency range around the center frequency.

/// **About the sweep steps:** The specified tuning step in each frequency band (in VFO mode) or programmed tuning step (in memory mode) is used during sweep.

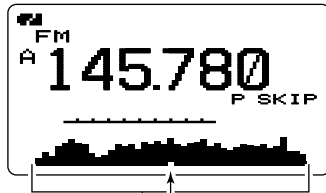

Band scope indication      Sweep marker

### ◇ Single sweep

- ① Set the desired frequency as band scope center frequency.
- ② Push and hold **[SCOPE](1)** for 1 sec. to start a single sweep.
  - 1 short and 1 long beeps sound.
  - Signal conditions (strengths) appear starting from the center of the range.
- ③ Rotate **[DIAL]** to set the highlighted cursor to the desired signal and set the frequency of the signal.
- ④ Push **[VFO]** to return to normal operation.

### ◇ Continuous sweep

- ① Set the desired frequency as band scope center frequency.
- ② Push and hold **[SCOPE](1)** for 3 sec. to start continuous sweep.
  - 2 short beeps sound after 1 short and 1 long beeps.
  - Signal conditions (strengths) appear starting from the center of the range.
- ③ Push and hold **[SCOPE](1)** for 1 sec. to cancel sweep.
  - Pushing **[SQL]** also cancels sweep.
- ④ Push **[VFO]** to return to normal operation.

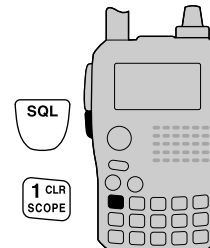

/// The receive audio during sweeping can be muted in sounds set mode. See page 102 for details.

## 5 BASIC OPERATION

### ■ Transmitting

**CAUTION:** Transmitting without an antenna will damage the transceiver.

/// **NOTE:** To prevent interference, listen on the channel before transmitting by pushing and holding **[SQL]**.

- ① Set the operating frequency. (pgs. 18, 19)
  - Transmission is available on the 144 MHz/430 MHz amateur bands only.
  - Select output power if desired. See the section at right for details.
- ② Push and hold **[PTT]** to transmit.
  - Tx/Rx indicator lights red.
  - S/Rx meter shows the output power level.
- ③ Speak into the microphone using your normal voice level.
  - DO NOT hold the transceiver too close to your mouth or speak too loudly. This may distort your speech.
- ④ Release **[PTT]** to return to receive.

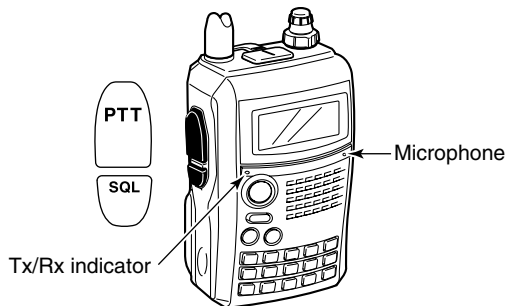

### ■ Transmit power selection

The transceiver has two output power levels to suit your operating requirements. Low output power during short-range communications may reduce the possibility of interference to other stations and will reduce current consumption.

➔ Push and hold **[LOW](3)** for 1 sec. to toggle the transmit output power between High and Low.

- “LOW” appears when the low power is selected.

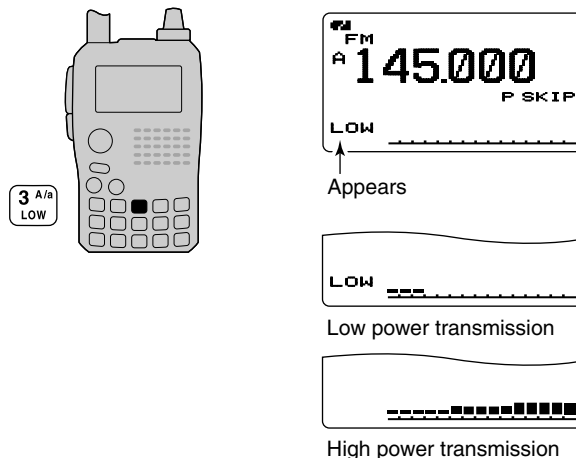

## ■ Lock function

To prevent accidental frequency changes and unnecessary function access, use the lock function.

- ➔ Push and hold **[MENU/LOCK]** for 1 sec. to turn the lock function ON and OFF.
  - “” appears while the lock function is activated.
  - The squelch control and volume control can be used while the lock function is in use with default setting. Either or both the squelch control and volume control can also be locked in set mode. (p. 90)

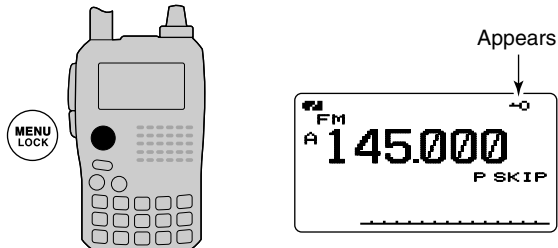

## ■ Dualwatch operation

Dualwatch operation monitors two frequencies simultaneously. The IC-E91 has two independent receiver circuits as A band and B band (available frequency bands and operating mode are different depending on bands).

### ◇ Dualwatch operation

- ➔ Push and hold **[MAIN/DUAL]** for 1 sec. to turn the dualwatch operation ON and OFF.
  - While in dualwatch operation, the display indicates A band in the upper half and B band in the lower half.

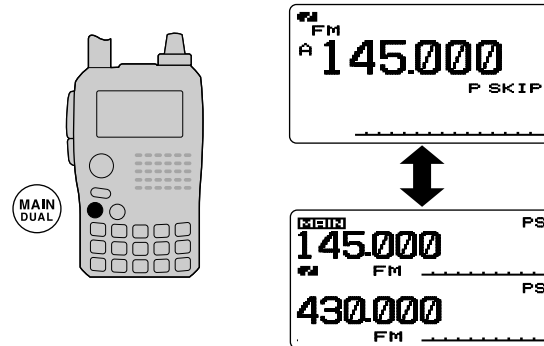

## 5 BASIC OPERATION

### ◇ Main band selection

- Push **[MAIN/DUAL]** to select A band or B band as the main operating band alternately.

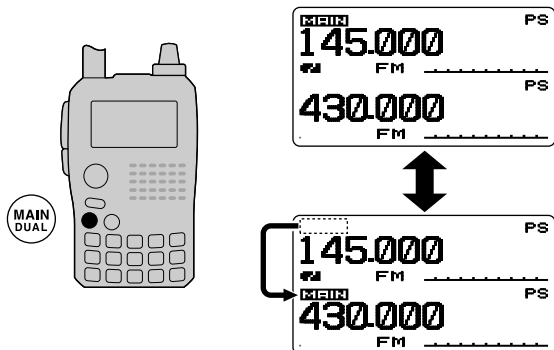

### ◇ Setting audio volume

The audio level for dualwatch operation can be adjusted both on A band and B band simultaneously (default). This setting can be set separately for each band in sounds set mode.

- ① Push and hold **[MAIN/DUAL]** for 1 sec. to enter the dual-watch operation, if necessary.
- ② Rotate **[VOL]** to adjust the audio level for the main band.
  - If squelch is closed, push and hold **[SQL]** to verify the audio level.
  - The display shows the volume level while setting.

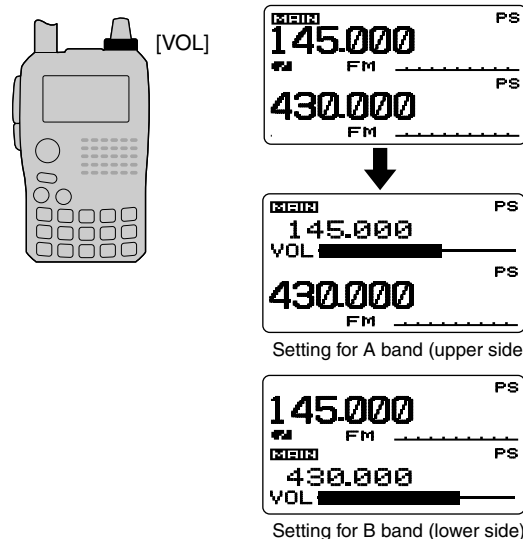



◆ **Volume setting for dualwatch**

The volume setting for dualwatch can be set for both bands simultaneously or for each band separately in set mode.

- ① Enter “VOLUME SELECT” in sounds set mode. (p. 102)

◀MENU screen▶ ⇄ ◀SOUNDS▶ ⇄ ◀VOLUME SELECT▶  
 (Push [MENU/LOCK]) (Rotate [DIAL]†, then push [↵](5)†.)

- ② Rotate [DIAL]† to select “BOTH” or “SEPARATE.”
- ③ Push [↵](5) (or [←](4)) to return to sounds set mode, and push [MENU/LOCK] to return to frequency indication.

◆ **Setting squelch level**

- ① Push and hold [MAIN/DUAL] for 1 sec. to enter the dual-watch operation, if necessary
- ② While pushing and holding [SQL], rotate [DIAL] to adjust the main band’s squelch level.
  - “LEVEL 1” is loose squelch and “LEVEL 9” is tight squelch.
  - “AUTO” indicates automatic level adjustment with a noise pulse count system.
  - “OPEN” indicates continuously open setting.

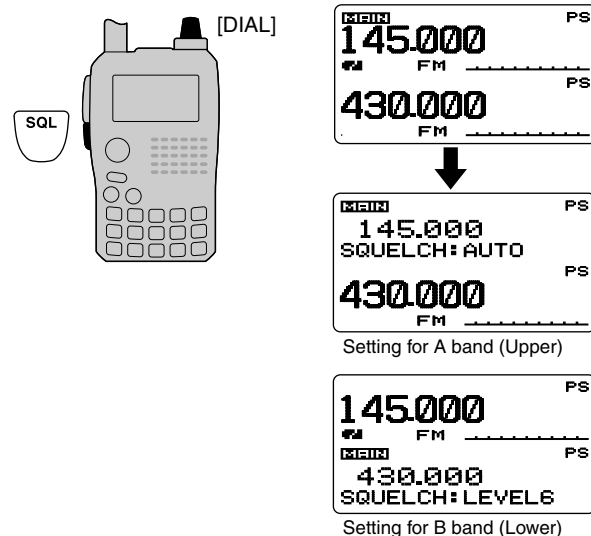

†[DIAL] ⇄ [▲](2)/[▼](8)

[↵](5) ⇄ [▶](6)

## ■ TV channel operation

TV channel operation is available only when TV channels are programmed using the optional RS-91. (p. 121) Also available for A band operation only.

### ◇ TV channel receiving

- ① Push **[CALL]** several times to select TV channels.
  - “TV” and channel number appear.
- ② Rotate **[DIAL]** to select the desired channel.
  - While pushing and holding **[BAND]**, rotating **[DIAL]** selects the all channels including skip channel.

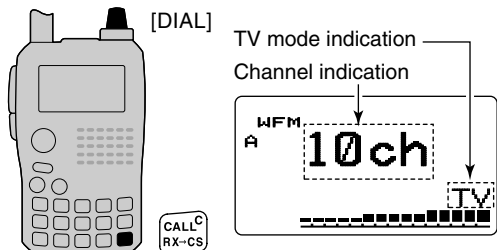

### ◇ Skip channel setting

Unwanted channels can be skipped for rapid selection, etc.

- ① Push **[CALL]** several times to select TV channels.
  - “TV” and channel number appear.

- ② Rotate **[DIAL]** to select the channel to be skipped.
  - To clear the skip setting, rotate **[DIAL]** while pushing and holding **[BAND]** to select a skip channel.
- ③ Push and hold **[SKIP](5)** for 1 sec. to toggle the skip setting ON and OFF.
  - “SKIP” appears when the channel is set as skip channel.

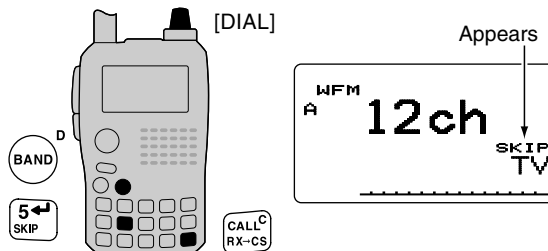

### ◇ Automatic TV channel programming

TV channels can be programmed automatically.

- ① Push **[CALL]** several times to select TV channels.
  - “TV” and channel number appear.
- ② Push **[SCAN](2)** to start TV channel programming.
  - The programming will automatically stop after scanning all channels.

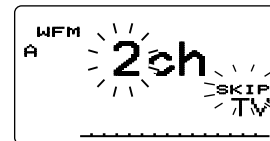

## ■ General

Repeaters allow you to extend the operational range of your radio because a repeater has much higher output power than the typical transceiver.

Normally, a repeater has independent frequencies for each receiver and transmitter.

A subaudible tone may also be required to access a repeater.

Reference amateur radio hand books and local ham magazines for details of local repeaters such as repeater input/output frequencies and locations.

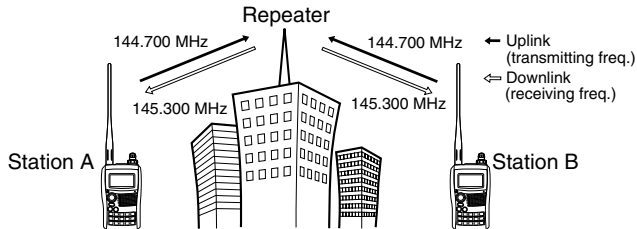

### • Repeater operation flow chart

**Step 1:**

Set the desired band to operate the repeater.

**Step 2:**

Set the desired receive frequency (repeater output frequency).

**Step 3:**

Set the duplex (shifting) direction (- duplex or +duplex).  
- Set the offset frequency (shifting value), if required.

**Step 4:**

Set the subaudible tone (repeater tone) encoder function ON.  
- Set the subaudible tone frequency, if required.

• Repeater settings can be stored into a memory channel.

## 6 REPEATER AND DUPLEX OPERATIONS

### ■ Accessing a repeater

- ① Set the receive frequency (repeater output frequency).
- ② Set the shift direction of the transmit frequency. (-DUP or +DUP; see p. 32 for details.)

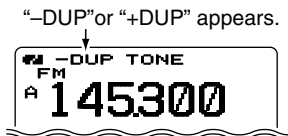

- ③ Push and hold [TONE](7) for 1 sec. to activate the sub-audible tone encoder, according to repeater requirements.
  - “TONE” appears.

Refer to p. 107 for tone frequency settings.

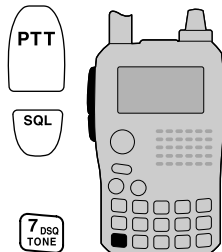

- ④ Push and hold [PTT] to transmit.
  - The displayed frequency automatically changes to the transmit frequency (repeater input frequency).
  - If “OFF” appears, check the offset frequency or shift direction. (p. 30)

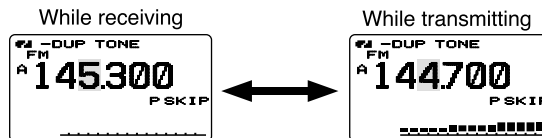

- ⑤ Release [PTT] to receive.
- ⑥ Push and hold [SQL] to check whether the other station's transmit signal can be directly received or not.

◇ **Checking the repeater input signal**

The transceiver can check whether the other station's transmit signal can be received directly or not, by listening on the repeater input frequency.

- ➔ Push and hold **[SQL]** to check whether the other station's transmit signal can be directly received or not.
  - When the other station's signal can be directly received, move to a non-repeater frequency to use simplex. (duplex OFF)

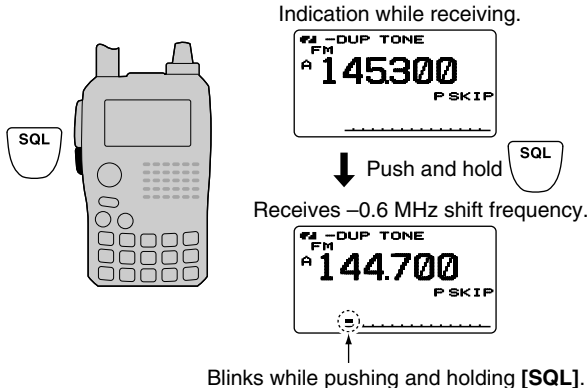

◇ **Off band indication**

If the transmit frequency is out of the amateur band, the off band indication, "OFF," appears on the display when **[PTT]** is pushed. Check the offset frequency or duplex direction in this case. (p. 32)

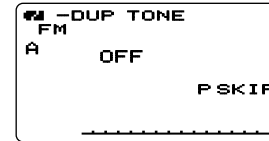

✓ **CONVENIENT!**

**Tone scan function:** When you don't know the subaudible tone used for a repeater, the tone scan is convenient for detecting the tone frequency.

- ➔ Push and hold **[T.SCAN](9)** for 1 sec. to start the tone scan. See p. 112 for more information.

## 6 REPEATER AND DUPLEX OPERATIONS

### ■ Duplex operation

Although [DIAL] and [↵](5) are used for description in this section, [▲](2)/[▼](8) and [▶](6) are available instead of [DIAL] and [↵](5).

#### ◇ Setting offset frequency

- ① Enter "OFFSET FREQ" in DUP/TONE... set mode. (p. 97)  
◀MENU screen▶ ↔ ▶DUP/TONE...◀ ↔ ▶OFFSET FREQ◀  
(Push [MENU/LOCK]) (Rotate [DIAL]<sup>†</sup>, then push [↵](5)<sup>†</sup>.)
- ② Rotate [DIAL]<sup>†</sup> to set offset frequency.
  - 1 MHz and 10 MHz tuning steps are available by pushing and holding [MHz](VFO) for 1 sec.: push [MHz](VFO) to cancel it.
- ③ Push [↵](5) (or [◀](4)) to return to DUP/TONE... set mode, and push [MENU/LOCK] to return to frequency indication.

No offset frequency

OFFSET FREQ  
0. 000. 00

5.0 MHz offset

OFFSET FREQ  
5. 000. 00

#### ◇ Setting duplex direction

- ➡ Push and hold [DUP](4) for 1 sec. to select "-DUP" or "+DUP".
- "-DUP" or "+DUP" indicates the transmit frequency for minus shift or plus shift, respectively.
  - **When offset frequency is 0.6 MHz.**

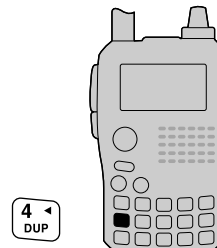

<sup>†</sup>[DIAL] ↔ [▲](2)/[▼](8)

[↵](5) ↔ [▶](6)

## ■ 1750 Hz tone

Some European repeaters require a 1750 Hz tone burst to be accessed. For such European repeaters, perform the following.

- This tone can be use as a 'Call signal' in countries out of Europe.

- ① Push and hold **[DTMF.M](.)** for 1 sec. to select DTMF memory.



- ② Rotate **[DIAL]**<sup>†</sup> counter-clockwise until "T-CALL" appears.



- ③ Push **[J](5)** to set.
- ④ Push **[VFO]** to exit DTMF memory.
- ⑤ Set the receive frequency (repeater output frequency).
- ⑥ Set the shift direction of the transmit frequency. (-DUP or +DUP; see p. 32 for details.)
- ⑦ While pushing **[PTT]**, push **[SQL]** to transmit a 1750 Hz tone burst signal.
  - If "OFF" appears, check the offset frequency or shift direction. (p. 97)
  - The displayed frequency automatically changes to the transmit frequency (repeater input frequency).

- ⑧ Push and hold **[PTT]** to transmit.
- ⑨ Release **[PTT]** to receive.
- ⑩ Push and hold **[SQL]** to check whether the other station's transmit signal can be received directly or not, by listening on the repeater input frequency.

<sup>†</sup>[DIAL] ↔ [▲](2)/[▼](8)

Although [DIAL] and [↵](5) are used for description in this section, [▲](2)/[▼](8) and [▶](6) are available instead of [DIAL] and [↵](5).

## ■ Digital mode operation

When the optional UT-121 is installed, the IC-E91 can be operated in digital voice mode and low-speed data operation for both transmit and receive. It can also be connected to a GPS receiver (compatible with an RS-232 output/NMEA format/4800 bps) and transmit/receive position data.

## ■ Call sign programming

Four types of call sign memories are available; your own call sign “MY CALL SIGN,” other station call sign “YOUR CALL SIGN,” repeater call sign “RPT1 CALL SIGN” and “RPT2 CALL SIGN.” “MY CALL SIGN” can store up to 6 call signs, “YOUR CALL SIGN” can store up to 60 call signs and “RPT1/2 CALL SIGN” can store up to 60 call signs, and each call sign can be programmed with up to 8 characters.

### ◆ Your own call sign programming

Your own call sign must be programmed for both digital voice and low-speed data communications (including GPS transmission).

- ① Select B band as the main band. (p. 14)
- ② Enter “MY” in call sign set mode.

◀MENU screen▶ ↔ ◀CALL SIGN▶ ↔ ◀MY▶  
(Push [MENU/LOCK]) (Rotate [DIAL]†, then push [↵](5)†.)

- MY CALL SIGN screen is displayed.

```

MY CALL SIGN
▶M01

◀ : SET      ▲▼ : SEL
◀ : BACK    ▶ : EDIT
                CLR : CLR
  
```

- ③ Rotate [DIAL]† to select the desired call sign memory, “M01” to “M06.”
- ④ Push [▶](6) to enter call sign programming mode.
  - The 1st digit blinks.

```

MY CALL SIGN
▶M01      AB
  █
  █
  █
◀ : SET  CLR : CLR
▲▼ : SEL A/a : CHAR
▶ : CUR
  
```

- ⑤ Rotate [DIAL]† to select the desired character or code.
  - Push [A/a](3) to change the character group from “AB” (alphabetical characters; capital letters), “12” (numbers) and “/” (symbols) in sequence.



- ⑥ Push **[▶](6)** to select 2nd digit, then rotate **[DIAL]†** to select the desired character or code.

- Push **[▶](6)** to move the cursor right; push **[◀](4)** to move the cursor left.
- 2nd digit blinks (1st digit stops blinking).



- ⑦ Repeat the steps ⑤ and ⑥ to enter your own call sign.
- Up to a 8-digit of call sign can be set.
  - If an un-necessary character is entered, push **[▶](6)** or **[◀](4)** to select the character, then push **[CLR](1)** to erase the selected character, or push and hold **[CLR](1)** for 1 sec. to erase all characters following the cursor.
  - When programming a note (Up to a 4-digit for operating radio type or area, etc.), go to step ⑧, otherwise go to step ⑩.
- ⑧ Push **[▶](6)** several times to set the cursor beside “ ” indication.
- ⑨ Repeat steps ⑤ to ⑥ to program the desired 4-character note.

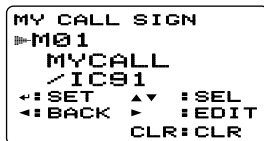

- ⑩ Push **[↵](5)** to store the programmed call sign with note and returns to MY CALL SIGN screen.
- ⑪ Push **[MENU/LOCK]** to return to frequency indication.

†[DIAL] ↔ [▲](2)/[▼](8)

[↵](5) ↔ [▶](6)

## 7 DV MODE OPERATION (Optional UT-121 is required)

### ◆ Station call sign programming

Station call sign must be programmed for the specified station call as well as repeater operation in both digital voice and low-speed data communications.

- ① Select B band as the main band. (p. 14)
- ② Enter "UR" in call sign set mode.

**<MENU screen>** ⇨ **<CALL SIGN>** ⇨ **<UR>**  
(Push **[MENU/LOCK]**) (Rotate **[DIAL]**<sup>†</sup>, then push **[↵](5)**<sup>†</sup>.)

- YOUR CALL SIGN screen is displayed.

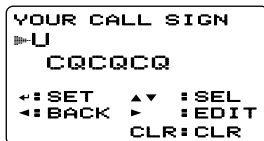

- ③ Rotate **[DIAL]**<sup>†</sup> to select the desired call sign memory, "U01" to "U60."
- ④ Push **[▶](6)** to enter call sign programming mode.
  - The 1st digit blinks.

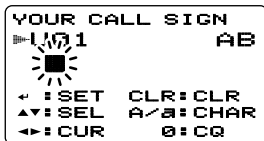

- ⑤ Rotate **[DIAL]**<sup>†</sup> to select the desired character or code.
  - Push **[A/a](3)** to change the character group from "AB" (alphabetical characters; capital letters), "12" (numbers) and "/" (symbols) in sequence.

- ⑥ Push **[▶](6)** to select 2nd digit, then rotate **[DIAL]**<sup>†</sup> to select the desired character or code.
  - Push **[▶](6)** to move the cursor right; push **[◀](4)** to move the cursor left.
  - 2nd digit blinks (1st digit stops blinking).

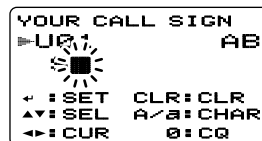

- ⑦ Repeat the steps ⑤ and ⑥ to enter the desired station call sign.
  - Up to an 8-digit of call sign can be set.
  - If an un-necessary character is entered, push **[▶](6)** or **[◀](4)** to select the character, then push **[CLR](1)** to erase the selected character, or push and hold **[CLR](1)** for 1 sec. to erase all characters following the cursor.

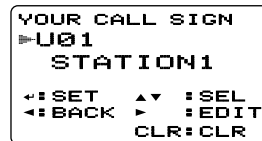

- ⑧ Push **[↵](5)** to store the programmed call sign and returns to YOUR CALL SIGN screen.
- ⑨ Push **[MENU/LOCK]** to return to frequency indication.

/// **NOTE:** During the call sign programming mode (④ to ⑦), push **[CQ](0)** to set “CQCQCQ,” and push **[CQ](0)** again to return to the previously stored call sign.

---

✓ **For your information**

The IC-E91 has call sign edit record function.

When editing a call sign stored in a call sign memory, regular memory or call channel, the default setting is to store the edited call sign into a blank channel automatically. (“FULL” is displayed when all call sign memory is programmed.)

The edited call sign can be over-written when the setting of the EDIT RECORD is set to OFF or SELECT. (p. 95)

However, you must manually over-write a programmed call sign in regular memory and call channels. (Temporary operation without over-writing is possible.)

---

## 7 DV MODE OPERATION (Optional UT-121 is required)

### ■ Digital voice mode operation

- ① Set the desired frequency in B band. (pgs. 14, 18)
  - Select output power, if desired. (p. 24)
- ② Select DV mode. (p. 21)
- ③ Set your own call sign for DV operation as follows.
  - 1] Enter “MY” in call sign set mode.

◀MENU screen▶ ⇄ ▶CALL SIGN▶ ⇄ ▶MY▶  
(Push [MENU/LOCK]) (Rotate [DIAL]†, then push [↵](5)†.)

- 2] Rotate [DIAL]† to select the desired your own call sign channel (if you have programmed several call signs) then push [↵](5) to set the call sign and return to CALL SIGN screen.
  - See page 34 for your own call sign programming details.

```
CALL SIGN
=>UR:
R1:
R2: NOT USE*
MY: MYCALL
/IC91
```

- ④ Set the desired call sign as described in “When calling the desired station (p. 39)” or “When sending a CQ (p. 39).”
- ⑤ Push and hold [PTT] to transmit and speak into the microphone at normal voice level.
  - Tx/Rx indicator lights red and the RF meter shows the output power.
- ⑥ Release [PTT] to return to receive.
  - The other station call sign will be received.
  - Received call signs can be stored into the received call record automatically. See page 93 for details.

/// **NOTE:** The digital mode operation is vastly different from FM mode. One of the differences is in digital mode the squelch does not function as in FM mode. Changing the squelch setting will not open it to hear the hiss of “White Noise.” It only activates for digital squelch functions such as CSQL (Digital code squelch) or DSQL (Digital call sign squelch).

### ◆ When calling the desired station

Continued instruction from step 2 on page 38.

- 3 Rotate **[DIAL]**† to select “UR,” then push **[↵](5)**†.
  - YOUR CALL SIGN screen is displayed.
- 4 Rotate **[DIAL]**† to select the call sign channel in which desired station’s call sign is programmed.
  - See page 36 for station call sign programming details.
- 5 Push **[↵](5)** to set the station’s call sign and return to CALL SIGN screen.

```
CALL SIGN
▶UR: STATION1
R1:
R2: NOT USE*
MY: MYCALL
  /IC91
```

- 6 Push **[MENU/LOCK]** to return to frequency indication.
- 7 Perform the instruction steps 5 and 6 on page 38.

### ◆ When sending a CQ

Continued instruction from step 2 on page 38.

- 3 Rotate **[DIAL]**† to select “UR,” then push **[↵](5)**†.
  - YOUR CALL SIGN screen is displayed.
- 4 Rotate **[DIAL]**† to select the call sign channel in which “CQCQCQ” is programmed.
  - Or, select “U” then push **[▶](6)** and **[CQ](0)** in sequence to set “CQCQCQ.”
- 5 Push **[↵](5)** to set “CQCQCQ” as the call sign and return to CALL SIGN screen.

```
CALL SIGN
▶UR: CQCQCQ
R1:
R2: NOT USE*
MY: MYCALL
  /IC91
```

- 6 Push **[MENU/LOCK]** to return to frequency indication.
- 7 Perform the instruction step 5 and 6 on page 38.

## 7 DV MODE OPERATION (Optional UT-121 is required)

### ■ About D-STAR system

In the D-STAR system, repeater linking via a 10 GHz band backbone and internet network (gateway connection) capabilities are available. This system provides you with much wider coverage range during digital voice mode operation.

#### • D-STAR system outline

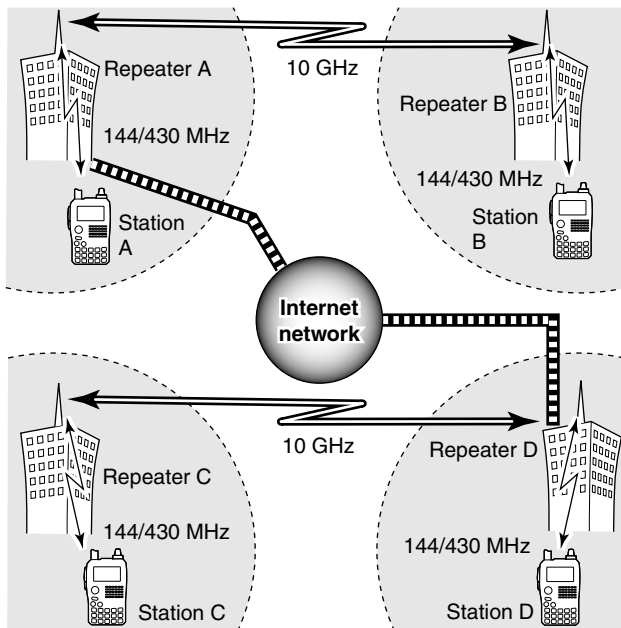

For current repeater operation, stations that are communicating must both be in the same repeater's operating area. However, in the D-STAR system as in the illustration at left, the repeaters can be linked via the system repeaters (with a 10 GHz signal). Thus stations A and B can communicate even though they are in different repeater operating areas.

Also, the D-STAR system repeaters are connectable through the internet— gateway connection capability.

For example, when station B uses the gateway connection station B can communicate with the station C! By using the gateway connection, long distance communication like DX operation may be possible with 144 or 430 MHz digital voice!

In the D-STAR system, an independent repeater's operating area is called an Area and a group of linked repeaters via a 10 GHz backbone is called a Zone.

**NOTE:** The digital repeater for IC-E91 (144 MHz or 430 MHz of amateur radio band operation) is not available in European countries at present of May 2006.

#### **About time-out timer function**

The IC-E91 has a time-out timer function for digital repeater operation. The timer limits a continuous transmission for approx. 10 min. Warning beeps will sound before 30 sec. (approx.) and just before the timer functioning.

## ■ Digital repeater operation

Repeater call signs must be programmed for repeater operation in both digital voice and low-speed data communications.

### ◆ Repeater call sign programming

- ① Select B band as the main band. (p. 14)
- ② Enter "R1" or "R2" in call sign set mode.  
 <MENU screen> ⇨ <CALL SIGN> ⇨ <R1>/<R2>  
 (Push [MENU/LOCK]) (Rotate [DIAL]†, then push [↵](5)†.)
  - RPT1 or RPT2 CALL SIGN screen is displayed.
- ③ Rotate [DIAL]† to select the desired call sign memory, "R01" to "R60."
- ④ Push [▶](6) to enter call sign programming mode.
  - The 1st digit blinks.
- ⑤ Rotate [DIAL]† to select the desired character or code.
  - Push [A/a](3) to change the character group from "AB" (alphabetical characters; capital letters), "12" (numbers) and "/" (symbols) in sequence.
  - Set "/" at the 1st digit then set the desired area repeater's call sign (in a different zone) for CQ call ("/" stands for "CQCQCQ") in a different zone operation. (p. 44)
- ⑥ Push [▶](6) to select 2nd digit, then rotate [DIAL]† to select the desired character or code.
  - Push [▶](6) to move the cursor right; push [◀](4) to move the cursor left.
  - 2nd digit blinks (1st digit stops blinking).

- ⑦ Repeat the steps ⑤ and ⑥ to enter the desired repeater call sign.
  - Up to an 8-digit of call sign can be set.
  - Push [7] when setting with the gateway connection if the selected repeater has gateway capability. (The gateway connection can be set in RPT1 only when "NOT USE\*" is set to RPT2.)
  - If an un-necessary character is entered, push [▶](6) or [◀](4) to select the character, then push [CLR](1) to erase the selected character, or push and hold [CLR](1) for 1 sec. to all characters following the cursor.

```

RPT1 CALL SIGN
R01
RPT1AA G

←:SET      ▲▼:SEL
←:BACK    ▶:EDIT
           CLR:CLR
  
```

- ⑧ Push [↵](5) to store the programmed call sign and returns to RPT1 or RPT2 CALL SIGN screen.
- ⑨ Push [MENU/LOCK] to return to frequency indication.

†[DIAL] ↔ [▲](2)/[▼](8)

[↵](5) ↔ [▶](6)

## 7 DV MODE OPERATION (Optional UT-121 is required)

### ◆ Repeater operation in the same zone

- ① Set the desired repeater's frequency, offset and shift direction in B band. (pgs. 18, 32)
  - Select DV mode in advance. (p. 21)
- ② Set your own call sign. (p. 38)
  - See p. 34 for your own call sign programming.
- ③ Set the desired station call sign. (p. 39)
  - See p. 36 for station call sign programming.
- ④ Set the repeater's call sign as follows;
  - 1 Enter "R1" in call sign set mode.

◀MENU screen▶ ↔ ▶CALL SIGN▶ ↔ ▶R1▶  
(Push [MENU/LOCK]) (Rotate [DIAL]†, then push [↵](5)†.)

- 2 Rotate [DIAL]† to select the nearest repeater's call sign.
- 3 Push [↵](5) to set the call sign for "R1."
  - Return to CALL SIGN screen.
- 4 Rotate [DIAL]† to select "R2" then push [↵](5)†.
  - RPT2 CALL SIGN screen is displayed.
- 5 Rotate [DIAL]† to select the desired repeater's (in the same zone) call sign.
  - Select "NOT USE\*" when not operating RPT2.
- 6 Push [↵](5) to set the call sign for "R2."
  - Return to CALL SIGN screen.

```
CALL SIGN
UR: CQCQCQ
R1: RPT1AA
R2: NOT USE*
MY: MYCALL
/IC91
```

- 7 Push [MENU/LOCK] to return to frequency indication.

†[DIAL] ↔ [▲](2)/[▼](8)

[↵](5) ↔ [▶](6)



### • Setting example 1

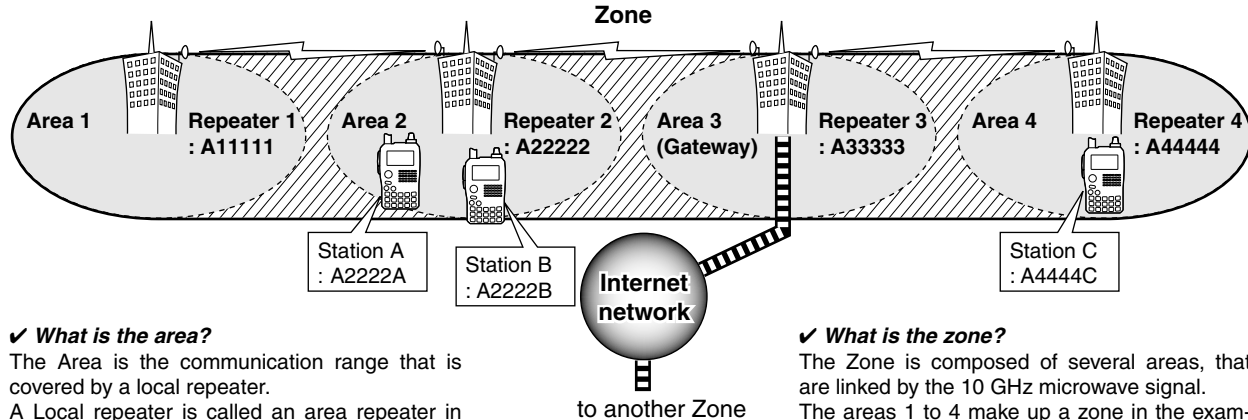

#### ✓ What is the area?

The Area is the communication range that is covered by a local repeater.  
A Local repeater is called an area repeater in the D-STAR system.

#### ✓ What is the zone?

The Zone is composed of several areas, that are linked by the 10 GHz microwave signal.  
The areas 1 to 4 make up a zone in the example above.

#### The setting when Station A is calling Station B

UR : A2222B  
R1 : A22222  
R2 : NOT USEQ  
MY : A2222A

#### The setting when Station A is making a CQ call in area 1

UR : CQCQCQ  
R1 : A22222  
R2 : A11111  
MY : A2222A

#### The setting when Station A is calling Station C

UR : A4444C  
R1 : A22222  
R2 : A44444  
MY : A2222A

## 7 DV MODE OPERATION (Optional UT-121 is required)

### ◆ Repeater operation into another zone

- ① Set the desired repeater's frequency, offset and shift direction in B band. (pgs. 18, 32)
  - Select DV mode in advance.
- ② Set your own call sign. (p. 38)
  - See p. 34 for your own call sign programming.
- ③ Set the desired station call sign. (p. 39)
  - **When making a CQ call**  
Set the desired repeater's (in a different zone) call sign with a "/" symbol at the 1st digit, for the area in which you want to make a CQ call, into "UR."
  - See p. 36 for station call sign programming.
- ④ Set the repeater's call sign as follows;
  - ① Enter "R1" in call sign set mode.

◀MENU screen▶ ↔ ▶CALL SIGN▶ ↔ ▶R1▶  
(Push [MENU/LOCK]) (Rotate [DIAL]<sup>†</sup>, then push [↵](5)<sup>†</sup>.)

- ② Rotate [DIAL]<sup>†</sup> to select the nearest repeater's call sign.
  - If the nearest repeater is gateway repeater, select the repeater's call sign with "G" setting at the 8th digit.
- ③ Push [↵](5) to set the call sign for "R1."
  - Return to CALL SIGN screen.
- ④ Rotate [DIAL]<sup>†</sup> to select "R2" then push [↵](5)<sup>†</sup>.
- ⑤ Rotate [DIAL]<sup>†</sup> to select the gateway repeater's (in the same zone) call sign.
  - The call sign should have "G" setting at the 8th digit.
  - When gateway repeater call sign is set in "R1," select "NOT USE\*" for "R2" setting.

- ⑥ Push [↵](5) to set the call sign for "R2."
  - Return to CALL SIGN screen.

```
CALL SIGN
▶UR: CQCQCQ
R1: RPT1AA
R2: NOT USE*
MY: MYCALL
  /IC91
```

- ⑦ Push [MENU/LOCK] to return to frequency indication.
- ⑤ Push [PTT] to transmit; release to receive.

<sup>†</sup>[DIAL] ↔ [▲](2)/[▼](8)

[↵](5) ↔ [▶](6)

• Setting example 2

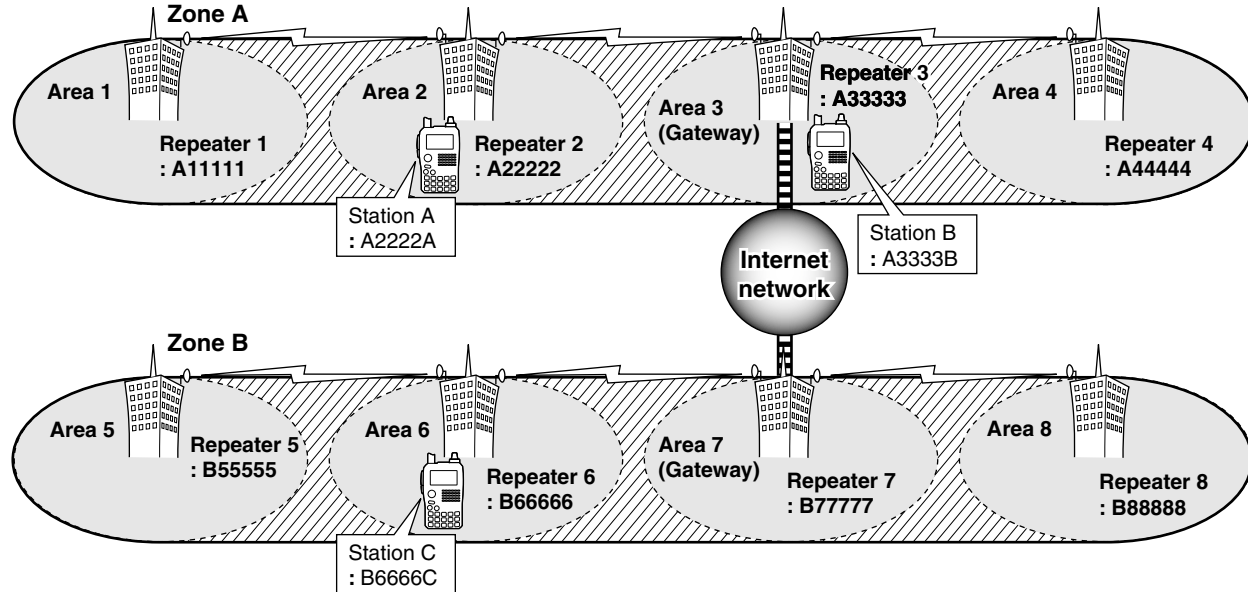

The setting when Station A is calling Station C

UR : B6666C  
 R1 : A22222  
 R2 : A33333 G  
 MY : A2222A

The setting when Station A is making a CQ call in area 8

UR : /B88888  
 R1 : A22222  
 R2 : A33333 G  
 MY : A2222A

The setting when Station B is calling Station C

UR : B6666C  
 R1 : A33333 G  
 R2 : NOT USE\*  
 MY : A3333B

## 7 DV MODE OPERATION (Optional UT-121 is required)

### ■ Received call sign

When a call is received in DV mode, the calling station and the repeater call signs being used can be stored into the received call record. The stored call signs are viewable in the following manner.

Up to 20 calls can be recorded.

#### ◇ Desired call record indication

① Enter RX call sign set mode.

⟨MENU screen⟩ ⇄ ⟨RX CALL SIGN⟩  
(Push [MENU/LOCK]) (Rotate [DIAL]<sup>†</sup>, then push [↵](5)<sup>†</sup>.)

• RX CALL SIGN screen is displayed.

② Rotate [DIAL]<sup>†</sup> to select the desired record channel.

③ To confirm the received call, push [↵](5) several times to select the desired call sign from CALLER, CALLED, RXRPT1 and RXRPT2.

**CALLER** : The station call sign that made a call.

**CALLED** : The station call sign called by the caller.

**RXRPT1** : The repeater call sign used by the caller station.

**RXRPT2** : The repeater call sign linked from RXRPT1.

④ Push [MENU/LOCK] to return to frequency indication.

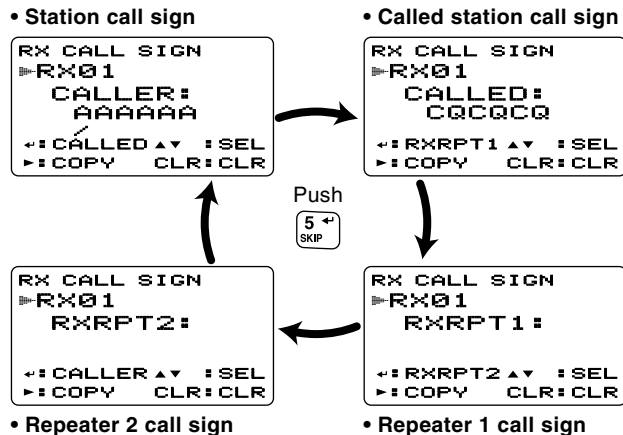

**NOTE:** When a call is received in DV mode when the power save function is activated, the call sign may not be received correctly.

This is normal, not a malfunction, because of header of the call sign cannot be detected during power save.

Turn the power save function OFF (p. 114) if you want to receive a call sign correctly even in stand-by condition.

#### ✓ For your information

When receiving a call, the received station call sign is automatically displayed and scrolled in sequence at the bottom line of the function display.

This can be turned OFF in display set mode. (p.100)

<sup>†</sup>[DIAL] ⇄ [▲](2)/[▼](8)

[↵](5) ⇄ [▶](6)

### ◆ One-touch reply using the call record

The stored call signs in the call record can be used to the call.

- ① After receiving a call, push and hold [RX→CS](CALL) for 1 sec.  
Or, while pushing and holding [RX→CS](CALL), rotate [DIAL] to select the desired call sign record.

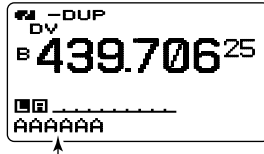

The received call sign is displayed while pushing and holding [CALL/RX→CS] when [DIAL] is rotated while [CALL/RX→CS] is pushed.

- Set your own call sign (MY) in advance. (p. 34)
  - The call sign stored in "CALLER" is stored as "UR," "RXRPT1" is stored as "R2" and "RXRPT2" is stored as "R1."
  - Error beeps sound when a call sign is received incorrectly, and no call sign is set in this case.
- ② Push [PTT] to transmit; release to receive.

#### **Important!**

Setting call signs with the "One-touch reply using the call record" operation as at left are for temporary operation only. Therefore, the set call signs will be overwritten when another call record is used to set call signs.

- Never saved into a call sign memory.

If you want to save the set call signs, see "Copying the call record contents into call sign memory" (p. 50) for details.

#### ✓ **For your information**

When a call specifying your call sign is received, the call signs of the calling station and the repeater it is using can be used for operation automatically.

- When "RX call sign auto write" (p. 93) is set to "AUTO," the station call sign in "CALLER" is set to "UR" automatically.
- When "Repeater call sign auto write" (p. 93) is set to "AUTO," the stored station call sign in "RXRPT1" is stored as "R2" and "RXRPT2" is stored as "R1" automatically.

## ■ Copying the call sign

### ◇ Copying the call sign memory contents

This function is convenient when or modifying a part of the current call sign.

**NOTE:** Make sure that the “EDIT RECORD” item in DV set mode is set to “AUTO” or “SELECT” in advance. (p. 95)

① During DV mode operation, enter call sign set mode.

⟨MENU screen⟩ ⇄ ⟨CALL SIGN⟩  
(Push [MENU/LOCK]) (Rotate [DIAL]<sup>†</sup>, then push [↵](5)<sup>†</sup>.)

- CALL SIGN screen is displayed.
- ② Rotate [DIAL]<sup>†</sup> to select “UR,” “R1” or “R2” as desired, then push [↵](5)<sup>†</sup>.
- ③ Rotate [DIAL]<sup>†</sup> to select the desired call sign channel to be copied.
  - U01–U60 and R01–R60 are available.

### • When “AUTO” is set to “EDIT RECORD” item

- ④ Push [▶](6) to select the call sign programming mode.
- A blank channel is selected automatically.
  - The 1st digit of the selected call sign blinks.



- ⑤ Edit or modify the selected call sign as described in “◇ Station call sign programming” (p. 36) or “◇ Repeater call sign programming” (p. 41).
- ⑥ Push [↵](5) to store the edited/modified call sign into the selected blank channel.

**NOTE:** The message “FULL” is displayed when no blank channel is available in station or repeater call sign memory.

Select the desired call sign channel number as described in step ⑦ of “• When “SELECT” is set to “EDIT RECORD” item” at right-hand page in this case.

• **When “SELECT” is set to “EDIT RECORD” item**

- ④ Push [▶](6) to select the call sign programming mode.
  - The 1st digit of the selected call sign blinks.
- ⑤ Edit or modify the selected call sign as described in “◊ Station call sign programming” (p. 36) or “◊ Repeater call sign programming” (p. 41).
- ⑥ Push [↵](5).
  - Call sign channel number blinks.

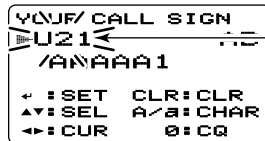

Call sign channel number blinks.

- ⑦ Rotate [DIAL]<sup>†</sup> to select the desired call sign channel to store.
- ⑧ Push [↵](5) to store the edited/modified call sign into the selected channel.

<sup>†</sup>[DIAL] ↔ [▲](2)/[▼](8)

[↵](5) ↔ [▶](6)

## 7 DV MODE OPERATION (Optional UT-121 is required)

### ◇ Copying the call record contents into call sign memory

This is a way to copying the call record contents (“CALLER,” “RXRPT1” and “RXRPT2”) into call sign memory (“UR,” “R1” and “R2”) at the same time or individually.

- ① Perform the steps ① to ③ of “◇ Desired call record indication” (p. 46) to select the desired call record or call sign.
- ② Push [▶](6) to select copy select mode.
  - COPY SELECT screen is displayed.

```
COPY SELECT
RX01
▶ALL

◀◀:BACK  ▲▲:SEL
▶:LIST  C:CURR
```

- ③ Rotate [DIAL]<sup>†</sup> to select the desired call sign to be copied from “ALL,” “RXRPT1” and “RXRPT2.”
  - “ALL” selection won’t appear when either station or repeater call sign memory has no blank channel.

#### • When “ALL” is selected

- ➡ Push [▶](6) to copy the selected record’s contents into the appropriate call sign memory.
  - Returns to RX CALL SIGN screen automatically.

#### • When “CALLER,” “RXRPT1” or “RXRPT2” is selected

- ① Push [▶](6) then rotate [DIAL]<sup>†</sup> to select the desired condition of call sign memory channel selection to be copied to from “AUTO” and “LIST SEL.”
  - “AUTO” selection won’t appear when the appropriate call sign memory has no blank channel.
  - Go to step ④ when “AUTO” is selected.

```
COPY SELECT
RX01
▶AUTO
LIST SEL

◀◀:BACK  ▲▲:SEL
▶:LIST
```

- ② Push [▶](6), then select the desired call sign memory channel to copy to with [DIAL].
- ③ Push [▶](6) to copy the call sign into the selected call sign memory.
  - Returns to RX CALL SIGN screen automatically.
- ④ Push [MENU/LOCK] to return to frequency indication.

<sup>†</sup>[DIAL] ↔ [▲](2)/[▼](8)

[↵](5) ↔ [▶](6)



## ■ Break-in communication

The break-in function allows you to break into a conversation, where the two original stations are communicating with call sign squelch enabled.

- ① While receiving another station's communication, push and hold **[RX→CS](CALL)** for 1 sec. to set the communicating station's call sign.
  - When a call sign has not been received correctly, error beeps sound and no call sign is set. Receive the call sign of a communicating signal again, or set the call sign manually.
- ② Push and hold **[BK](9)** for 1 sec. to turn the break-in function ON.
  - "BK" appears.

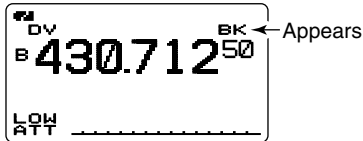

- ③ When both stations are in standby, push **[PTT]** to transmit a break-in call.
  - The programmed call sign station receives the break-in call as well as your call sign.
- ④ Wait for the reply call from the station who receives the break-in call.
- ⑤ After receiving the reply call, communicate normally.
- ⑥ To cancel the break-in, push and hold **[BK](9)** for 1 sec. to turn OFF.

### • How to use the break-in?

While operating with the call sign squelch (p. 110), the squelch never opens (no audio sounds) even if a call is received, unless your own call sign ("MY") is specified. However, when the call including the "BK ON" signal (break-in call) is received, the squelch will open and audio sounds even if the call is specified for another station.

#### • Station C calling to Station A with "BK OFF"

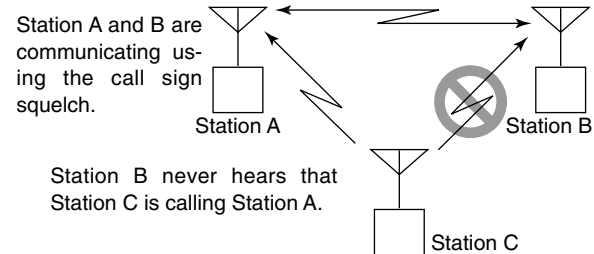

#### • Station C calling to Station A with "BK ON"

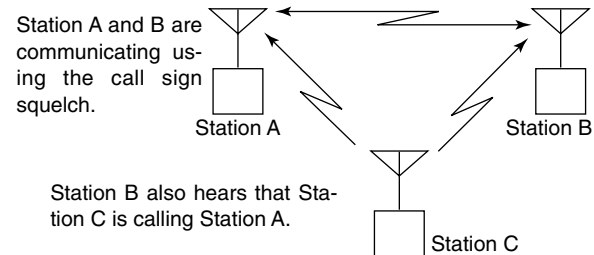

## ■ Message operation

### ◇ TX message programming

TX messages are available for up to 5 channels and each channel can be programmed with a message of up to 20 characters. Available characters are **0** to **9**, **A** to **Z** (capital letters), **a** to **z** (lower case letters), some symbols and space.

① Enter "TX MESSAGE" in message/position set mode.

◀MENU screen> ⇄ ◀MESSAGE/POSITION> ⇄ ◀TX MESSAGE>

(Push [MENU/LOCK]) (Rotate [DIAL]<sup>†</sup>, then push [↵](5)<sup>†</sup>.)

- TX MESSAGE screen is displayed.

② Rotate [DIAL]<sup>†</sup> to select the desired transmit message channel.

- Ch01 to Ch05 and OFF are available.
- Previously message is displayed if programmed.

③ Push [▶](6) to select the message edit condition.

- The 1st digit of the message blinks.



④ Rotate [DIAL]<sup>†</sup> to select the desired character or symbol.

- Push [A/a](3) to change the character group from "AB" (alphabetical characters; capital letters), "ab" (alphabetical characters; lower case letters), "12" (numbers) and "!" (symbols) in sequence.
- If an un-necessary character is entered, push [▶](6) or [◀](4) to select the character, then push [CLR](1) to erase the selected character, or push and hold [CLR](1) for 1 sec. to erase all characters following the cursor.

⑤ Push [▶](6) to select 2nd digit, then rotate [DIAL]<sup>†</sup> to select the desired character or code.

- Push [▶](6) to move the cursor right; push [◀](4) to move the cursor left.
- 2nd digit blinks (1st digit stops blinking).

⑥ Repeat the steps ④ and ⑤ to enter the desired message.

- Up to 20-character messages can be set.



⑦ Push [↵](5) to store the message.

⑧ Push [MENU/LOCK] to return to frequency indication.

## ◇ Message Transmission

Select the message transmission function ON (Ch01–05) and OFF. When a message channel is selected, the transceiver transmits a text message (pre-programmed). (default: OFF)

- ① Set the operating frequency, call signs and other settings, such as repeater, as desired in B band.
- ② Perform the steps ① to ③ in “◇ TX message programming” as at left.
- ③ Rotate **[DIAL]**† to select the desired message channel.
  - “Ch01” to “Ch05” available.
  - See left-hand pages for message programming.
- ④ Push **[J](5)** to set the message for transmission.
- ⑤ Push **[PTT]** to transmit the selected message.
  - The message is transmitted each time [PTT] is pushed.
  - The message is transmitted each 30 sec. automatically during continuous transmission.
- ⑥ Release **[PTT]** to return to receive.
- ⑦ When the reply call with a message is received, the call sign and the message scrolls at the bottom of the function display.

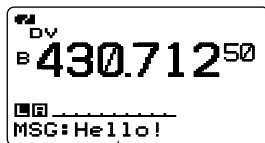

Scrolls the received message.

### ✓ For your information

The automatic received call sign and/or message indication can be turned OFF in display set mode, if desired.

- RX CALL SIGN (p. 100)
- RX MESSAGE (p. 101)

**NOTE:** Only 1 message can be stored in the IC-E91. The received message is cleared by turning power OFF, or overwritten when another message is received.  
A transmitted message that includes lower case characters from the IC-E91 may not be decoded and displayed correctly by the ID-800H, IC-V82/U82, etc.

7

†[DIAL] ↔ [▲](2)/[▼](8)

[J](5) ↔ [▶](6)

## 7 DV MODE OPERATION (Optional UT-121 is required)

### ◇ RX message indication

The received message can also be checked in DV set mode.

- ① Select “RX MESSAGE” in message/position set mode.

⟨MENU screen⟩ ⇨ ⟨MESSAGE/POSITION⟩ ⇨ ⟨RX MESSAGE⟩  
(Push [MENU/LOCK]) (Rotate [DIAL]<sup>†</sup>, then push [↵](5)<sup>†</sup>.)

- The received message is displayed in RX MESSAGE screen.

```
RX MESSAGE
⇨ MESSAGE :
 
Hello !
 
⇨ BACK ⇩ CALLER
```

- ② Rotate [DIAL] or push [▼](8) to display the station call sign.

```
RX MESSAGE
⇨ CALLER :
 
BBBBBB
 /
⇨ BACK ▲ MSG
```

- ③ Push [↵](5) or [◀](4) to return to MESSAGE/POSITION screen.
- ④ Push [MENU/LOCK] to return to frequency indication.

### ■ Automatic reply function

The automatic reply function replies to calls by a station that specified your call sign.

Two methods of replying are available— one is making a reply call with your own call sign, and other one is making a reply call with reply voice audio that has been recorded in DV voice memory.

### ◇ Automatic reply function setting

- ① Enter “AUTO REPLY” in DV set mode. (p. 92)

⟨MENU screen⟩ ⇨ ⟨DV SET MODE⟩ ⇨ ⟨AUTO REPLY⟩  
(Push [MENU/LOCK]) (Rotate [DIAL]<sup>†</sup>, then push [↵](5)<sup>†</sup>.)

- AUTO REPLY screen is displayed.
- ② Rotate [DIAL]<sup>†</sup> to select the desired reply condition.  
**OFF** : Deactivate the automatic reply function. (default)  
**ON** : Reply to the call with your own call sign.  
**VOICE** : Reply to the call with the recorded voice memory.

```
AUTO REPLY
⇨ OFF
ON
VOICE
```

- ③ Push [↵](5).
  - Returns to DV SET MODE screen automatically.
- ④ Push [MENU/LOCK] to return to frequency indication.

### ◇ Voice memory recording for automatic reply

#### **IMPORTANT!**

Deactivate the dualwatch function and set minimum [VOL] level when recording the DV voice memo. Otherwise received audio or unwanted noise from A band is also recorded into the voice memory.

- ① Select DV mode in B band, and deactivate the priority watch (p. 83) if activated.
- ② Enter "REPLY VOICE" in DV voice memo set mode.

◀MENU screen▶ ↔ ◀DV VOICE MEMO▶ ↔ ◀REPLY VOICE▶  
(Push [MENU/LOCK]) (Rotate [DIAL]†, then push [↵](5)†.)

- REPLY VOICE screen is displayed.

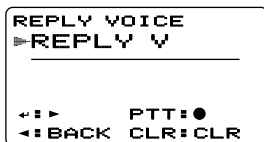

- ③ While pushing and holding [PTT], speak into the microphone.
  - Up to 10 seconds of message is recordable.
  - The recording stops after 10 second or when [PTT] is released.
- ④ Push [◀](4) to return to DV VOICE MEMO screen.
- ⑤ Push [MENU/LOCK] to return to frequency indication.

### ◇ Play-back or erase the voice memory

- ① Push [MENU/LOCK] to select menu mode indication.
- ② Rotate [DIAL]† to select "DV VOICE MEMO," then push [↵](5)†.
- ③ Rotate [DIAL]† to select "REPLY VOICE," then push [↵](5)†.
  - REPLY VOICE screen is displayed.
- ④ To play-back the recorded voice memory, push [↵](5).
  - Push [↵](5) again to pause, push [▶](6) to cancel the play-back.
- ⑤ To erase the recorded voice memory, push and hold [CLR](1) for 1 sec.

†[DIAL] ↔ [▲](2)/[▼](8)

[↵](5) ↔ [▶](6)

## 7 DV MODE OPERATION (Optional UT-121 is required)

### ■ EMR communication

The EMR communication mode is available for digital mode operation. In the EMR communication mode, no call sign setting is necessary. When an EMR communication mode signal is received, the audio (voice) will be heard at the specified level even the volume setting level is set to minimum level, or digital call sign/digital code squelch is in use.

- ① Set the desired frequency in 144 or 430 MHz band then push and hold **[EMR](.)** until 3 short and 1 long beeps sound to turn the EMR setting ON.
  - “EMR” appears

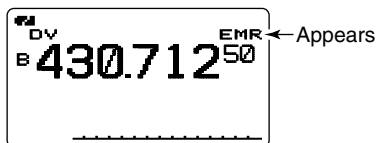

- ② Operate the transceiver normal way.
- ③ To cancel the EMR communication mode, push and hold **[EMR](.)** for 1 sec. to turn OFF.

### ■ Low-speed data communication

In addition to the digital voice communication, low-speed data communication is available.

The optional OPC-1529R DATA COMMUNICATION CABLE and serial data communication software (purchase locally) are required in addition.

The optional RS-91 REMOTE CONTROL SOFTWARE (OPC-1529R supplied) also includes a low-speed data communication capability.

/// **NOTE:** Turn OFF the GPS mode (p. 58) in advance to operate the low-speed data communication.

#### ◇ Connection

Connect the transceiver to your PC using with the optional OPC-1529R as illustrated below.

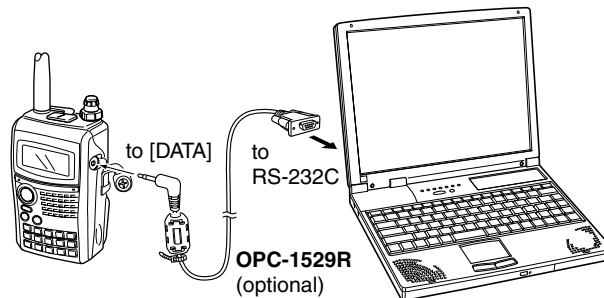

### ◇ Low-speed data communication application setting

Configure the low-speed data communication application as follows.

- Port : The same COM port number as IC-E91's
- Baud rate : 38.4 kbps (fixed value)
- Data : 8 bit
- Parity : None
- Stop : 1 bit
- Flow control : Xon/Xoff

### ◇ Low-speed data communication operation

**NOTE:** Confirm that in AUTO, the computer controls when [PTT] is activated to send data and the user doesn't have to operate the radio.

- ① Set your own, station call signs, etc. as described in "■ Digital voice mode operation" (p. 38) and "■ Digital repeater operation" (p. 41).
- ② Refer to the instructions of the low-speed data communication application.
- ③ To transmit data
  - With your voice audio, push and hold [PTT] to transmit while sending data from the PC. Release [PTT] to receive.
  - Under computer control, see Transmission condition setting at right.

### ◇ Transmission condition setting

- ① Enter "DV DATA TX" in DV set mode. (p. 92)

◀MENU screen▶ ↔ ◀DV SET MODE▶ ↔ ◀DV DATA TX▶  
(Push [MENU/LOCK]) (Rotate [DIAL]†, then push [↵](5)†.)

- ② Rotate [DIAL]† to select "PTT" or "AUTO."
- ③ Push [↵](5) (or [◀](4)) to return to DV set mode, and push [MENU/LOCK] to return to frequency indication.

†[DIAL] ↔ [▲](2)/[▼](8)

[↵](5) ↔ [▶](6)

## 7 DV MODE OPERATION (Optional UT-121 is required)

### ■ GPS operation

During GPS mode operation, a GPS receiver (RS-232C output/NMEA format) can be connected to the **[DATA]** socket of the IC-E91 to indicate the current position (Latitude and Longitude). The position data is transmitted with your voice signals at the same time.

In addition, the GPS message transmission is also available for the GPS mode operation.

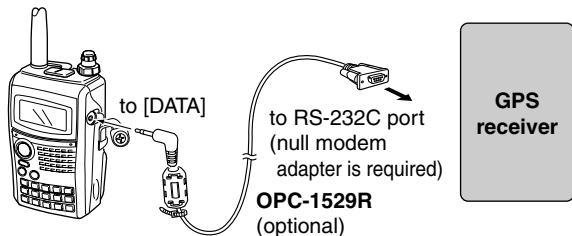

### ◇ Sentence formatter setting

① Enter “GPS MODE” in DV set mode. (p. 94)

⟨MENU screen⟩ ⇔ ⟨DV SET MODE⟩ ⇔ ⟨GPS MODE⟩  
(Push **[MENU/LOCK]**) (Rotate **[DIAL]**†, then push **[↵](5)**†.)

• GPS MODE screen is displayed.

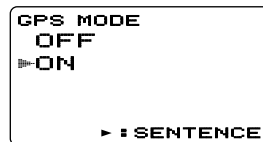

② Rotate **[DIAL]**† to select “ON.”

③ Push **[↵](5)**† to select GPS SENTENCE screen.

④ Rotate **[DIAL]**† to select the desired GPS sentence, then push **[↵](5)**.

• A total 5 sentences, RMC, GGA, GLL, GSA and VTG are available.

⑤ Rotate **[DIAL]**† to turn the sentence usage ON and OFF.

⑥ Push **[↵](5)** (or **[◀](4)**) to return to GPS SENTENCE screen.

⑦ Repeat the steps ④ to ⑥ to set another GPS sentence usage.

• Up to 3 GPS sentences are usable at the same time.

⑧ Push **[MENU/LOCK]** to return to frequency indication.



## ◇ GPS message programming

- ① Enter "GPS" in message/position set mode.

◀MENU screen> ↔ ◀MESSAGE/POSITION> ↔ ◀GPS>  
(Push [MENU/LOCK]) (Rotate [DIAL]<sup>†</sup>, then push [↵](5)<sup>†</sup>.)

- GPS MESSAGE screen is displayed.

- ② Push [▶](6) to select the message edit condition.

- The 1st digit of the message blinks.



- ③ Rotate [DIAL]<sup>†</sup> to select the desired character or symbol.
- Push [A/a](3) to change the character group from "AB" (alphabetical characters; capital letters), "ab" (alphabetical characters; lower case letters), "12" (numbers) and "!" (symbols) in sequence.
- ④ Push [▶](6) to select 2nd digit, then rotate [DIAL]<sup>†</sup> to select the desired character or code.
- Push [▶](6) to move the cursor right; push [◀](4) to move the cursor left.
  - 2nd digit blinks (1st digit stops blinking).

- ⑤ Repeat the steps ④ and ⑤ to enter the desired message.
- Up to 20-character messages can be set.



- ⑥ Push [↵](5) to store the message.
- ⑦ Push [MENU/LOCK] to return to frequency indication.

<sup>†</sup>[DIAL] ↔ [▲](2)/[▼](8)

[↵](5) ↔ [▶](6)

## 7 DV MODE OPERATION (Optional UT-121 is required)

### ◆ GPS message automatic transmission

① Enter “GPS AUTO TX” in DV set mode. (p. 95)

◀MENU screen> ⇨ <DV SET MODE> ⇨ <GPS AUTO TX>  
(Push [MENU/LOCK]) (Rotate [DIAL]<sup>†</sup>, then push [↵](5)<sup>†</sup>.)

- GPS AUTO RX screen is displayed.

```
GPS AUTO TX
▶OFF
 5SEC
10SEC
30SEC
1MIN
```

② Rotate [DIAL]<sup>†</sup> to select the desired position data transmitting interval from 5 sec., 10 sec., 30 sec., 1 min., 3 min., 5 min., 10 min., 30 min. and OFF.

- The position data is transmitted only when [PTT] is pushed with OFF setting, the data is transmitted automatically once every 5 sec., 10 sec., 30 sec., 1 min., 3 min., 5 min., 10 min. and 30 min. when the appropriate setting is selected.
- The GPS message is also transmitted if programmed.

③ Push [↵](5) (or [◀](4)) to return to DV SET MODE screen.

④ Push [MENU/LOCK] to return to frequency indication.

/// **NOTE:** Your own call sign (“MY”) should be set to activate the GPS automatic transmission.

### ◆ Position indication

① Enter “POSITION” in message/position set mode.

◀MENU screen> ⇨ <MESSAGE/POSITION> ⇨ <POSITION>  
(Push [MENU/LOCK]) (Rotate [DIAL]<sup>†</sup>, then push [↵](5)<sup>†</sup>.)

- GPS POSITION screen is displayed.

```
GPS POSITION
▶MY POSITION

 34.56.789 N
123.45.678 E
◀◀ BACK ▶▶ RX POS
```

② Rotate [DIAL]<sup>†</sup> to select the received position data indication.

③ Push [↵](5) (or [◀](4)) to return to MESSAGE/POSITION screen.

④ Push [MENU/LOCK] to return to frequency indication.

### ◆ Received GPS message indication

① Enter “RX GPS” in message/position set mode.

◀MENU screen▶ ↔ ◀MESSAGE/POSITION▶ ↔ ◀RX GPS▶  
(Push [MENU/LOCK]) (Rotate [DIAL]†, then push [↵](5)†.)

- RX GPS MESSAGE screen is displayed.

```
RX GPS MESSAGE
=DATA:

  Call from
  Osaka!

←←BACK
```

- ② Push [↵](5) (or [←](4)) to return to MESSAGE/POSITION screen.
- ③ Push [MENU/LOCK] to return to frequency indication.

†[DIAL] ↔ [▲](2)/[▼](8)

[↵](5) ↔ [▶](6)

## ■ Other functions for DV mode operation

### ◇ DV voice memory

The IC-E91 has a DV voice memory that records a total 30 second (approx.) of received audio.

The DV voice memory is divided into 2 tracks, 15 seconds each in a track, as the default setting.

### ◆ Recording received audio

- ① Select DV mode in B band, and deactivate the priority watch (p. 83) if activated.
- ② While receiving a DV signal, push [REC].



- ③ Rotate [DIAL] to select the desired track.
  - “\*” is displayed beside the track number when the selected track has been recorded.
- ④ Push [REC] to start recording.
  - Track counter (bar meter) is displayed during record.
  - The recording is paused automatically when the DV signal is interrupted or when the DV audio signal cannot be received correctly. Re-starts the recording when the DV audio signal is received correctly.
- ⑤ Push [REC] again to stop recording.
  - The recording stops automatically when the track becomes full.

### ◆ Track size setting

The track size can be changed with the following instruction.

- ① Enter “TRACK SIZE” in DV voice memo set mode.

◀MENU screen▶ ⇄ ◀DV VOICE MEMO▶ ⇄ ◀TRACK SIZE▶  
(Push [MENU/LOCK]) (Rotate [DIAL]<sup>†</sup>, then push [↵](5)<sup>†</sup>.)

- TRACK SIZE screen is displayed

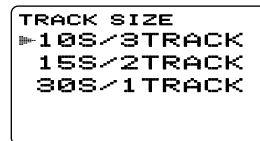

- ② Rotate [DIAL]<sup>†</sup> to select the desired track size.
  - 10S/3TRACK** : Makes 3 tracks and 10 seconds audio can be recorded in each track.
  - 15S/2TRACK** : Makes 2 tracks and 15 seconds audio can be recorded in each track.
  - 30S/1TRACK** : Makes 1 track only and 30 seconds audio can be recorded in a track.
- ③ Push [↵](5) (or [←](4)) to return to DV VOICE MEMO screen.
- ④ Push [MENU/LOCK] to return to frequency indication.

### ◆ Playing-back and erasing the recorded audio

- ① Select DV mode in B band, and deactivate the priority watch (p. 83) if activated.
- ② Enter "TRACK" in DV voice memo set mode.

⟨MENU screen⟩ ⇄ ⟨DV VOICE MEMO⟩ ⇄ ⟨TRACK⟩  
(Push [MENU/LOCK]) (Rotate [DIAL]<sup>†</sup>, then push [↵](5)<sup>†</sup>.)

- TRACK screen is displayed

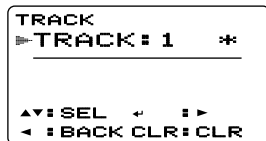

- ③ Rotate [DIAL]<sup>†</sup> to select the desired audio track to be play-back or erased.
  - "\*" is displayed beside the track number when the selected track has been recorded.
- ④ Push [↵](5) to play-back the recorded audio.
  - Push [↵](5) again to pause, push [▶](6) to stop play-back.
- ⑤ Push and hold [CLR](1) for 1 sec. to erase the recorded audio.
- ⑥ Push [◀](4) to return to DV VOICE MEMO screen.
- ⑦ Push [MENU/LOCK] to return to frequency indication.

### ◇ DV automatic detect

The "DV" mode indicator blinks when a non-DV signal is received during DV mode operation.

The IC-E91 DV automatic detection monitors in FM mode when other than DV mode signal is received.

- ① Enter "AUTO DETECT" in DV set mode. (p. 95)

⟨MENU screen⟩ ⇄ ⟨DV SET MODE⟩ ⇄ ⟨AUTO DETECT⟩  
(Push [MENU/LOCK]) (Rotate [DIAL]<sup>†</sup>, then push [↵](5)<sup>†</sup>.)

- ② Rotate [DIAL]<sup>†</sup> to turn the DV automatic detect function ON and OFF.

**OFF** : "DV" mode indicator blinks, however the transceiver receives in DV mode even if non-DV mode signals are received.

**ON** : "DV" mode indicator blinks and the transceiver monitors the signal in FM mode.

- ③ Push [↵](5) (or [◀](4)) to return to DV SET MODE screen
- ④ Push [MENU/LOCK] to return to frequency indication.

▨ **NOTE:** The received FM audio may be distorted when receiving an FM signal with DV automatic detect function.

<sup>†</sup>[DIAL] ⇄ [▲](2)/[▼](8)

[↵](5) ⇄ [▶](6)

## ■ General description

The IC-E91 has 850 memory channels in A band, 450 memory channels in B band, and 2 call channels in each band. Memory channels in each bands including 50 scan edge memory channels (25 pairs) for storage of often-used frequencies, respectively.

And a total of 26 memory banks, A to Z, are available in each bands for storing groups of frequencies, etc. Up to 100 channels can be assigned into a bank.

### ◇ Memory channel contents

The following information can be programmed into memory channels:

- Operating frequency (p. 18)
- Operating mode (p. 21)
- Duplex direction (+DUP or -DUP) with an offset frequency (p. 32)
- Subaudible tone encoder (p. 107), tone squelch or DTCS squelch ON/OFF (p. 110)
- Subaudible tone frequency (p. 107), tone squelch frequency or DTCS code with polarity (pgs. 107, 111)
- Scan skip information (p. 80)
- Memory bank (p. 67)
- Memory name (p. 70)
- Tuning step (p. 18)
- Call sign squelch or Digital code squelch\* (p. 110)
- Station call sign\* (p. 36)
- RPT1/RPT2 call sign\* (p. 41)

\*Available for B band operation only.

## ■ Selecting a memory channel

### ◇ Using [DIAL]— Programmed channels

- ① Push [MR] to select memory mode.
- ② Rotate [DIAL] to select the desired memory channel.
  - Only programmed channels are displayed.

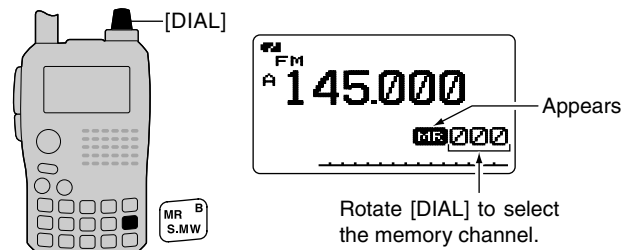

### ◇ Using [DIAL]— All channels

- ① Push [MR] to select memory mode.
- ② Push and hold [S.MW](MR) for 1 sec. to enter select memory write mode.
  - 1 short and 1 long beep sound.
  - "MR" indicator blinks.
- ③ Rotate [DIAL] to select the desired memory channel.
  - All channels are displayed.
  - Push [VFO] to return to memory mode indication.

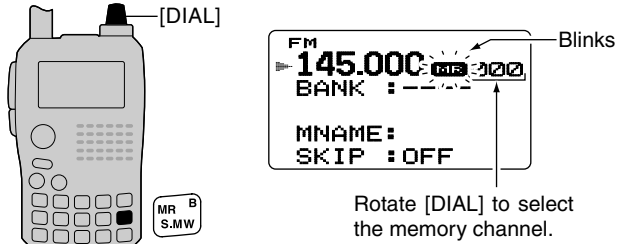

### ◆ Using the KEYPAD

- ① Push [MR] to select memory mode.
- ② Push the keypad to enter 3 digits to select the desired memory channel.
  - The blank channels are also selectable.

• **Example— selecting memory channel “25”**  
Push [MR] then push [0], [2], [5].

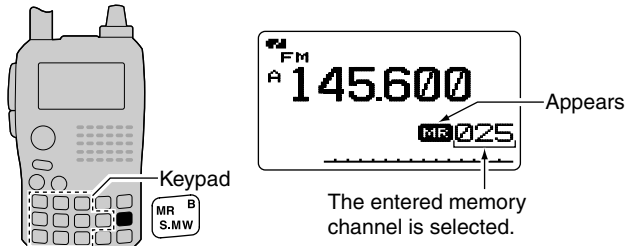

## ■ Selecting a call channel

- ① Push [CALL] to select call channel mode.
  - Pushing [CALL] toggles call, TV\* channels.
- ② Rotate [DIAL] to select the desired call channel.
  - “C0” and “C1” are selectable.

/// \*Appears only when TV channels are programmed via the optional RS-91. Also available for A band operation only.

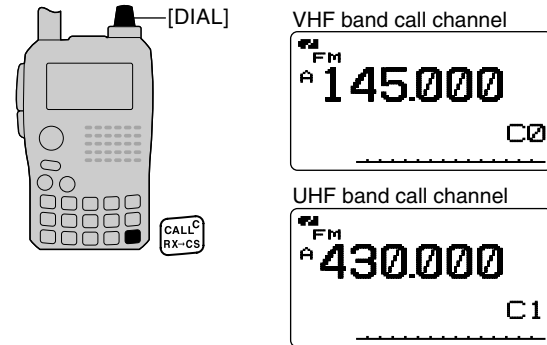

## Memory channel programming

- ① Push **[VFO]** to select VFO mode.
- ② Set the desired frequency:
  - ➔ Select the desired band with **[BAND]**.
  - ➔ Set the desired frequency with **[DIAL]**.
  - ➔ Or set the desired frequency with keypad directly.

In this case, the band and frequency settings with **[BAND]** and **[DIAL]** as above are not required.

  - ➔ Set other data (e.g. offset frequency, duplex direction, tone squelch, etc.), if desired.
- ③ Push and hold **[S.MW](MR)** for 1 sec. to enter select memory write mode.
  - 1 short and 1 long beep sound.
  - “**MR**” indicator blinks.
- ④ Rotate **[DIAL]** to select the desired channel.
  - Call channels (C0, C1), VFO (VFO) and scan edge channels (0A/0B to 24A/24B), as well as regular memory channels, can be programmed in this way.
- ⑤ Push and hold **[S.MW](MR)** for 1 sec. to program.
  - 3 beeps sound.
  - Memory channel number automatically increases when continuing to push and hold **[S.MW](MR)** for 3 sec. after programming.

**[EXAMPLE]:** Programming 145.870 MHz into memory channel 11 (blank channel).

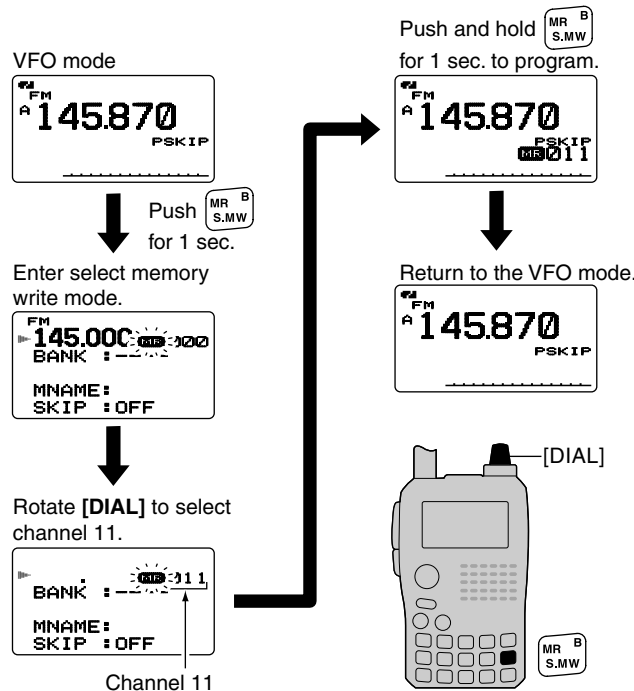



## ■ Memory bank setting

The IC-E91 has a total of 26 banks (A to Z). Regular memory channels, 000 to 799 (A band)/000 to 399 (B band), are assigned to the desired bank for easy memory management.

- ① Push and hold **[S.MW](MR)** for 1 sec. to enter select memory write mode.
  - 1 short and 1 long beep sound.
  - “**MR**” indicator blinks.
- ② Rotate **[DIAL]** to select the desired memory channel.
- ③ Push **[▲](2)** or **[▼](8)** to select “BANK.”
  - Bank group and channel number is displayed if the selected memory channel has already been previously assigned to a bank.

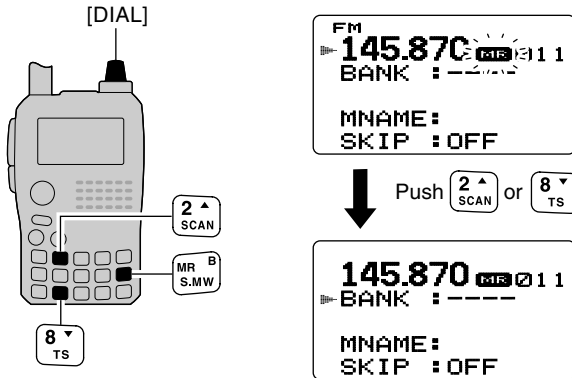

- ④ Push **[◀](4)** or **[▶](6)** several times to select the desired bank group from “A” to “Z.”

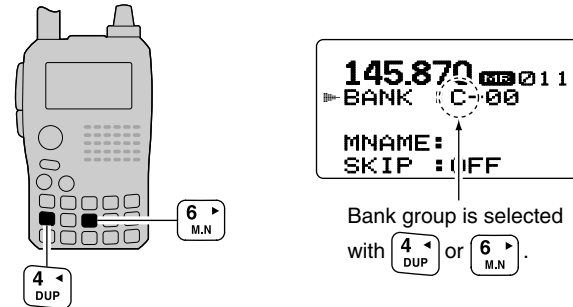

- ⑤ Rotate **[DIAL]** to select the bank channel number from “00” to “99.”
  - Only vacant bank channel numbers will be displayed.

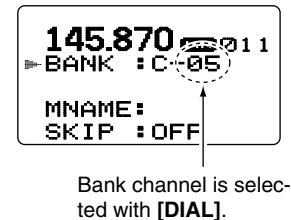

- ⑥ Push and hold **[S.MW](MR)** for 1 sec. to assign the channel to the bank.
  - Return to the previous indication.

## Memory bank selection

- ① Push **[MR]** several times to select memory bank mode.
- ② While pushing and holding **[BAND]**, rotate **[DIAL]** to select the desired bank (A to Z).
  - Only programmed banks are displayed.

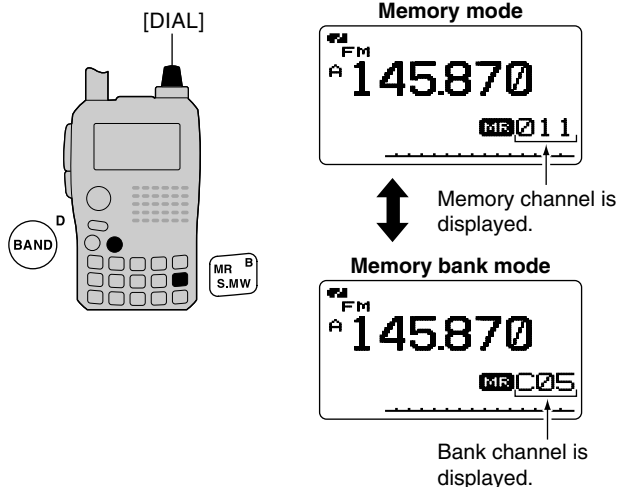

- ③ Rotate **[DIAL]** to select the bank channel.
  - Only programmed channels are displayed.

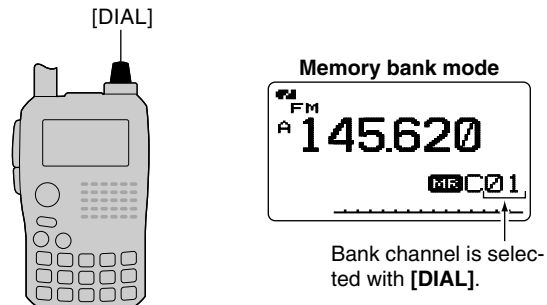

- ④ Push **[MR]** to return to regular memory condition.

## ■ Programming memory/bank/scan name

Each memory channel can be programmed with an alphanumeric channel name for easy recognition and can be indicated independently by channel. Names can be a maximum of 8 characters.

/// **NOTE:** Scan name indication can be turned ON or OFF in display set mode. (p. 101)

- ① Push **[MR]** to select memory mode.
  - When programming a call channel name, push **[CALL]** to select call channel mode.
- ② Rotate **[DIAL]** to select the desired memory channel.
  - Select scan edge channels (0A/0B to 24A/24B) for programming a scan name.
- ③ Push and hold **[S.MW](MR)** for 1 sec. to enter select memory write mode.
  - 1 short and 1 long beep sound.
  - “**MR**” indicator blinks.
- ④ Push **[▲](2)** or **[▼](8)** several times to select “BNAME,” “MNAME” or “SNAME” when programming the bank name, the memory name or the scan name, respectively.
  - After selecting the name to be programmed, a cursor blinks for the first character.
- ⑤ Rotate **[DIAL]** to select the desired character.
  - The selected character blinks.
  - Push **[A/a](3)** to change the character group from “AB” (alphabetical characters; capital letters), “ab” (alphabetical characters; lower case letters), “12” (numbers) and “!”” (symbols) in sequence.

- Push **[▶](6)** to move the cursor right; push **[◀](4)** to move the cursor left.
  - Push **[CLR](1)** to erase the selected character, or push and hold **[CLR](1)** for 1 sec. to erase all characters following the cursor.
- ⑥ Repeat step ⑤ until the desired channel name is programmed.
  - ⑦ Push and hold **[S.MW](MR)** for 1 sec. to program the name and exit channel name programming.
    - 3 beeps sound.

/// **NOTE:** Only one bank name can be programmed into each bank. Therefore, the previously programmed bank name will be displayed when bank name indication is selected. Also, the programmed bank name is assigned for the other bank channels automatically.

### ◇ Available characters

ABCDEFGHIJKLMNOPQRSTUVWXYZ
abcdefghijklmnopqrstuvwxyz
0123456789
! " # \$ % & ' ( ) * + , - . / : ; < = > ? @ [ \ ]
^ _ ` {   } ~ (Space)

## 8 MEMORY/CALL CHANNELS

**[EXAMPLE]:** Programming the bank name “AIR” into the scan edge channel 03A.

Push  to select memory mode.

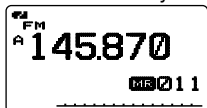

Rotate **[DIAL]** to select scan edge channel 03A.

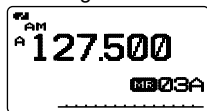



Push  for 1 sec.

Enter select memory write mode.



Scan edge channel “03A”

\*Select “MNAME” or “SNAME” when programming the memory name or the scan name, respectively.

Push  or  to select “BNAME”.\*



Rotate **[DIAL]** to enter “A”, push .



Enter “I” and “R” with **[DIAL]** and .



Push and hold  for 1 sec. to program.

## ■ Selecting memory/bank name indication

During memory mode operation, either the programmed memory name or bank name can be displayed below the frequency indication.

**NOTE:** The programmed scan name is displayed during the programmed scan edge channel selection.

- ① Push **[MR]** to select memory mode.
- ② While pushing **[M.N](6)**, rotate **[DIAL]** to select display indication type from bank name, memory name and OFF.

Name indication OFF.

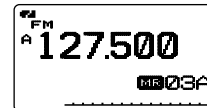

Memory name indication



Bank name indication



## ■ Copying memory/call contents

This function transfers a memory channel's contents to VFO (or another memory/call channel). This is useful when searching for signals around a memory channel frequency and for recalling the offset frequency, subaudible tone frequency etc.

### ◇ Memory/call ↔ VFO

- ① Select the memory (call) channel to be copied.
  - ➔ Push **[MR]** or **[CALL]** to select memory mode or call channel mode, then rotate **[DIAL]** to select the desired channel.
- ② Push and hold **[S.MW](MR)** for 1 sec. to enter select memory write mode.
  - 1 short and 1 long beep sound.
  - “**MR**” indicator blinks.
- ③ Rotate **[DIAL]** to select “VFO.”
- ④ Push and hold **[S.MW](MR)** for 1 sec. to write the selected channel contents to VFO mode.
  - Returns to VFO mode automatically.

/// Holding **[S.MW](MR)** for 2 sec. at the step ②, will also copy the memory contents to VFO. In this case, the steps ③ and ④ are not necessary.

### ◇ Memory/call ↔ memory/call

- ① Select the memory (call) channel to be copied.
  - ➔ Push **[MR]** or **[CALL]** to select memory mode or call channel mode, then rotate **[DIAL]** to select the desired memory channel.
- ② Push and hold **[S.MW](MR)** for 1 sec. to enter select memory write mode.
  - 1 short and 1 long beep sound.
  - “**MR**” indicator blinks.
  - Do not hold **[S.MW](MR)** for more than 2 sec. otherwise the memory contents will be copied to VFO.
- ③ Rotate **[DIAL]** to select the target memory (call) channel.
- ④ Push and hold **[S.MW](MR)** for 1 sec. again to copy.

#### [EXAMPLE]: Copying memory channel 11 to VFO.

During memory mode, rotate **[DIAL]** to select memory channel “11”.

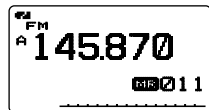

Push **[MR S.MW]**  
for 1 sec.



Rotate **[DIAL]** to select “VFO”.

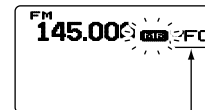

“VFO” is selected.

Push **[MR S.MW]**  
for 1 sec.

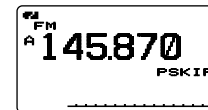

## Memory clearing

Contents of programmed memories can be cleared (blanked), if desired.

- ① Push and hold **[S.MW](MR)** for 1 sec. to enter select memory write mode.
  - 1 short and 1 long beeps sound.
  - “**MR**” indicator blinks.
  - Do not hold **[S.MW](MR)** for more than 2 sec. otherwise the memory contents will be copied to VFO.
- ② Rotate **[DIAL]** to select the desired memory channel to be cleared.
- ③ Push **[▲](2)** or **[▼](8)** to select “CLEAR.”
- ④ Push and hold **[S.MW](MR)** for 1 sec. to clear the contents.
  - 3 beeps sound.
  - The cleared channel changes to blank channel
  - Return to select memory write mode.— “**MR**” indicator blinks.
  - Push **[VFO]** to exit select memory write mode.

**NOTE:** Be careful!— the contents of cleared memories **CANNOT** be recalled.

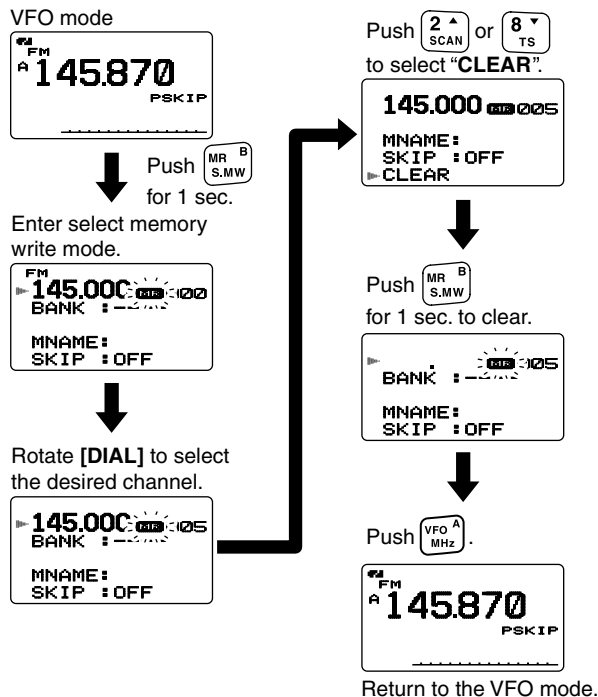

## Erasing/transferring bank contents

The bank contents of programmed memory channels can be cleared or reassigned to another memory bank.

**INFORMATION:** Even if the memory bank contents are cleared, the memory channel contents still remain programmed.

- Select the desired bank contents to be transferred or erased from the bank. (p. 68)
  - Push **[MR]** several times to select memory bank mode.
  - While pushing **[BAND]**, rotate **[DIAL]** to select the desired memory bank group.
  - Rotate **[DIAL]** to select the bank channel.

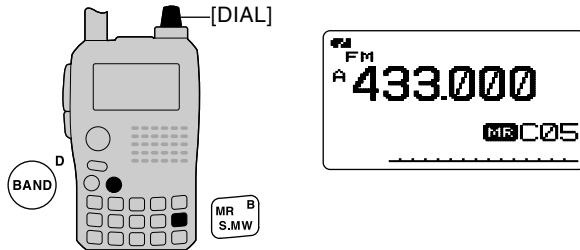

- Push **[S.MW](MR)** for 1 sec. to enter select memory write mode.
  - 1 short and 1 long beeps sound.
  - Displays the original memory channel number automatically and “**MR**” indicator blinks.
  - Do not hold **[S.MW](MR)** for more than 2 sec., otherwise the memory contents will be copied to VFO.

- Push **[▲](2)** or **[▼](8)** to select “BANK.”
- Push **[▶](6)** or **[◀](4)** several times to select the desired bank group to be transferred.
  - Select “----” indication when erasing the contents from the bank.
- Rotate **[DIAL]** to select the desired bank channel.
  - Skip this step when “----” indication is selected in step ④.

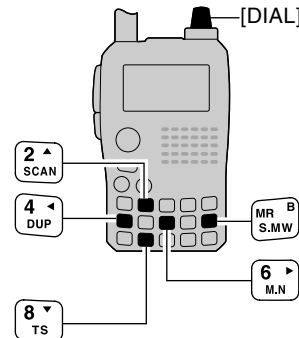

To transfer the bank contents to ch 11 in Bank B.

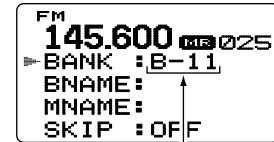

Bank channel is displayed.

To erase

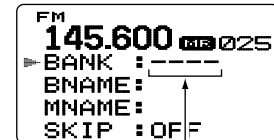

“----” is displayed.

- Push **[S.MW](MR)** for 1 sec. to erase/transferring the bank contents.

## Scan types

Scanning searches for signals automatically and makes it easier to locate new stations for contact or listening purposes.

There are 7 scan types and 4 resume conditions to suit your operating needs.

### FULL SCAN (p. 75)

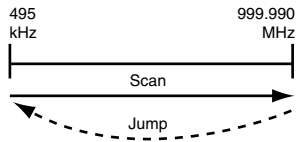

Repeatedly scans all frequencies over the entire band.

Some frequency ranges are not scanned according to the frequency coverage of the transceiver's version.

### SELECTED BAND SCAN (p. 75)

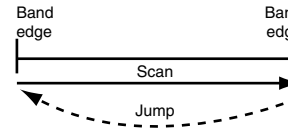

Repeatedly scans all frequencies over the entire selected band.

### PROGRAMMED SCAN (p. 75)

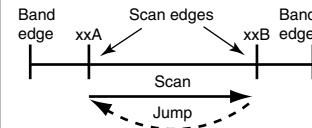

Repeatedly scans between two user-programmed frequencies. Used for checking for frequencies within a specified range such as repeater output frequencies, etc.

### MEMORY (SKIP) SCAN (p. 77)

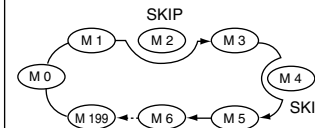

Repeatedly scans memory channels except those set as skip channel. Skip channels can be turned ON and OFF by pushing and holding **[SKIP](5)** in memory mode.

### ALL/SELECTED BANK SCAN (p. 78)

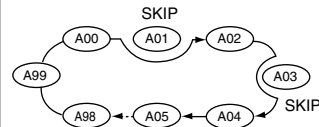

Repeatedly scans all bank channels or selected bank channels. The skip scan is also available.

### FREQUENCY/MEMORY SKIP FUNCTION (p. 79)

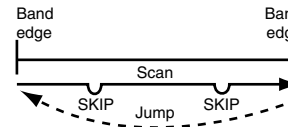

Skips unwanted frequencies or channels that inconveniently stop scanning. This function can be turned ON and OFF by pushing and holding **[SKIP](5)** in either VFO or memory mode.



## ■ Full/band/programmed scan

- ① Push [VFO] to select VFO mode.
  - Select the desired frequency band with [BAND], if desired.
- ② Set the squelch level.
- ③ While pushing and holding [SCAN](2), rotate [DIAL] to select the desired scanning type.
  - “ALL” for full scan; “BAND” for band scan, “PROG-xx (or scan name if programmed)” for programmed scan (xx= 0 to 24; programmed scan edges numbers are only displayed), “DUP” (appears only when duplex operation is set) for duplex scan.



### • Full scan selection

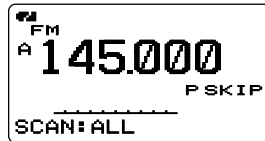

### • Band scan selection

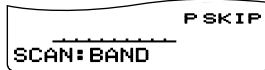

### • Programmed scan selection

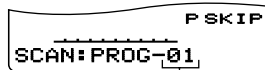

Selectable between “00” to “24” if programmed.

- ④ To start the scan, release [SCAN](2).
  - Scan pauses when a signal is received.
  - Rotate [DIAL] to change the scanning direction, or resumes manually.
  - Push [VFO] to stop the scan.

### • During full/band scan

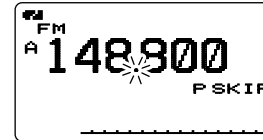

### • During programmed scan

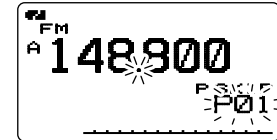

/// **About the scanning steps:** The selected tuning step in each frequency band (in VFO mode) is used during scan.

/// **Duplex scan function:** Repeatedly scans two frequencies (transmission/reception) during duplex scan operation.

### Scan name selection



Scan name

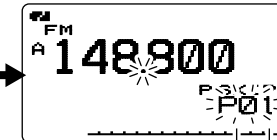

Scan edge number

Scan name is not displayed during a programmed scan.

## 9 SCAN OPERATION

### ■ Scan edges programming

Scan edges can be programmed in the same manner as memory channels. Scan edges are programmed into scan edges, 00A/00B to 24A/24B, in memory channels.

- ① Push **[VFO]** to select VFO mode.
- ② Set the desired frequency:
  - ➔ Select the desired band with **[BAND]**.
  - ➔ Set the desired frequency with **[DIAL]**.
  - ➔ Set other data (e.g. offset frequency, duplex direction, tone squelch, etc.), if desired.
- ③ Push and hold **[S.MW](MR)** for 1 sec. to enter the select memory write mode.
  - 1 short and 1 long beeps sound.
  - “**MR**” indicator blinks.
- ④ Rotate **[DIAL]** to select the desired programmed scan edge channel from 00A to 24A.

- ⑤ Push and hold **[S.MW](MR)** for 1 sec.
  - 3 beeps sound.
  - The other scan edge channel “B,” 00B to 24B, is automatically selected when continuing to push **[S.MW](MR)** after programming.
- ⑥ To program a frequency for the other pair of scan edges, 00B to 24B, repeat steps ② and ④.
  - If the same frequency is programmed into a pair of scan edges, programmed scan will not function.

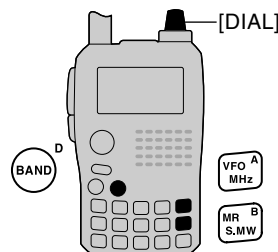

**[EXAMPLE]:** Programming 145.300 MHz into scan edges 03A.

Push **MR S.MW** for 1 sec.

Rotate **[DIAL]**

Push **MR S.MW** for 1 sec.

FM  
A 145.300  
P SKIP

FM  
145.00C  
BANK : 001  
MNAME :  
SKIP : OFF

FM  
BANK : 03A  
MNAME :  
SNAME :

FM  
A 145.300  
P SKIP  
03A

FM  
A 145.300  
P SKIP

## Memory scan

**IMPORTANT!**: To perform memory scan, 2 or more memory channels **MUST** be programmed, otherwise the scan will not start.

- ① Push **[MR]** to select memory mode.
- ② Set the squelch level.
- ③ While pushing and holding **[SCAN](2)**, rotate **[DIAL]** to select the desired scanning type.
  - “ALL” for full memory scan; “BAND” for band memory scan, “MODE” for mode scan, “DUP” (appears only when duplex operation is set) for duplex scan.

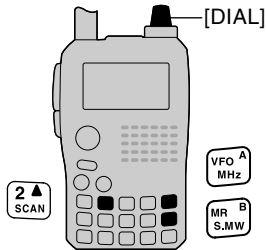

• All memory scan selection

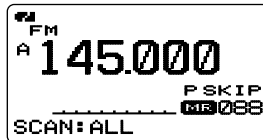

• Band memory scan selection



• Mode scan selection

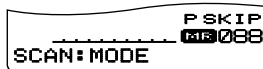

- ④ Release **[SCAN](2)** to start the selected scan.
  - Scan pauses when a signal is received.
  - Rotate **[DIAL]** to change the scanning direction, or resumes manually.
- ⑤ To stop the scan, push **[VFO]**.

• During memory scan

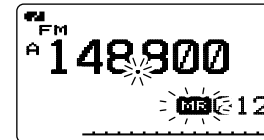

**Band memory scan function:** Repeatedly scans all memory channels programmed with any frequencies of the band programmed in the memory channel selected for scanning.

**Mode scan function:** Repeatedly scans all memory channels in which the same operating mode as the selected memory channel has been programmed.

**Duplex scan function:** Repeatedly scans two frequencies (transmission/reception) during duplex scan operation.

## Memory bank scan

**IMPORTANT!** To perform memory bank scan, 2 or more bank channels **MUST** be programmed, otherwise the scan will not start.

- ① Push **[S.MW](MR)** several times to select memory bank mode.
- ② Set the squelch level.
- ③ While pushing and holding **[SCAN](2)**, rotate **[DIAL]** to select the desired scanning type.
  - “ALL” for all bank scan; “BANK-LINK” for bank link scan or “BANK-x” for bank scan (x= A to Z; programmed bank groups are only displayed.), “DUP” (appears only when duplex operation is set) for duplex scan.

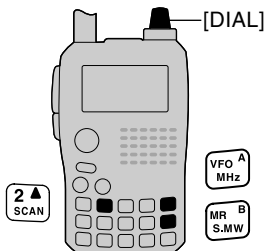

### • All bank scan selection

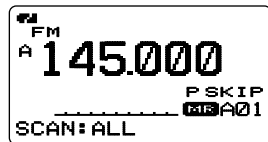

### • Bank link scan selection

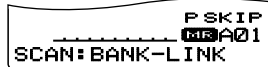

### • Bank scan selection



Selectable between “A” to “Z” if programmed.

- ④ Release **[SCAN](2)** to start the selected scan.
  - Scan pauses when a signal is received.
  - Rotate **[DIAL]** to change the scanning direction, or resumes manually.
- ⑤ To stop the scan, push **[VFO]**.

### • During all bank/bank link scan • During bank scan

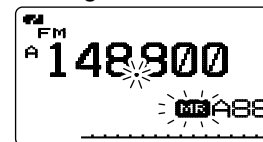
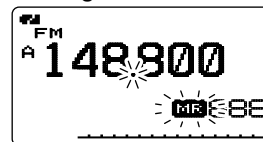

The bank-link setting can be changed in scan set mode. See page 97 for details.

**Duplex scan function:** Repeatedly scans two frequencies (transmission/reception) during duplex scan operation.

## ■ Skip channel/frequency setting

Memory channels can be set to be skipped for memory skip scan. In addition, memory channels can be set to be skipped for both memory skip scan and frequency skip scan. These are useful to speed up the scan rate.

① Select a memory channel:

- ➔ Push push **[MR]** to select memory mode.
- ➔ Rotate **[DIAL]** to select the desired channel to be a skip channel/frequency.

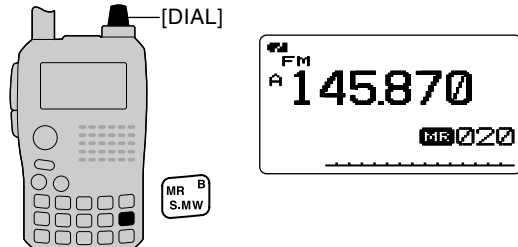

② Push and hold **[S.MW](MR)** for 1 sec. to enter select memory write mode.

③ Push **[▲](2)** or **[▼](8)** several times to select “SKIP.”

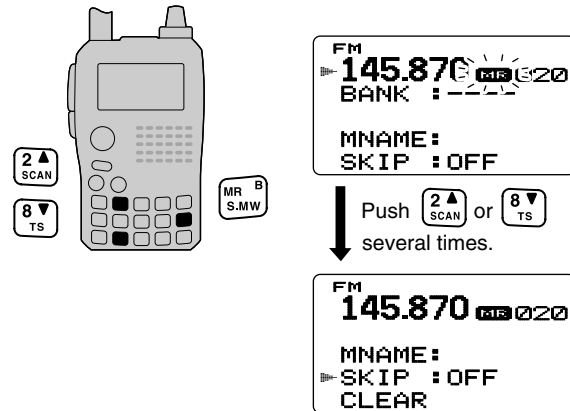

④ Rotate **[DIAL]** to select the skip condition from “SKIP,” “P SKIP” or “OFF” for the selected channel.

- P SKIP: The channel is skipped during memory/bank scan and the programmed frequency is skipped during VFO scan, such as programmed scan.
- SKIP : The channel is skipped during memory or bank scan.
- OFF : The channel is scanned during any scan.

(Continue to the next page.)

## 9 SCAN OPERATION

⑤ Push and hold **[S.MW](MR)** for 1 sec. to store the skip condition into the memory.

- “SKIP” or “P SKIP” indicator appears, according to the skip selection in the step ④.

### • Skip channel setting

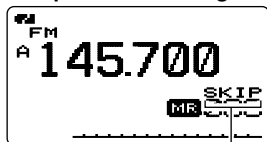

“SKIP” appears

### • Program skip setting

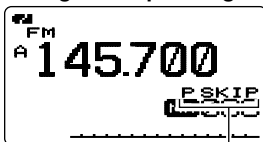

“P SKIP” appears

### ✓ CONVENIENT!

The the skip setting can be set with the following operation.

- ① Select the desired memory channel to be set as a skip channel/frequency.
- ② While pushing **[SKIP](5)**, rotate **[DIAL]** to select the skip condition from “P SKIP,” “SKIP” and “OFF (no indication).”

### ✓ CONVENIENT!

During VFO scanning, such as programmed scan, the skip setting can be programmed into the highest blank memory channel which is automatically selected with the following operation.

① Start the VFO scan.

- ➔ Push **[VFO]** to select VFO mode.
  - Select the desired frequency band with **[BAND]**, if desired.
- ➔ Set the squelch level.
- ➔ While pushing and holding **[SCAN](2)**, rotate **[DIAL]** to select the desired scanning type.
  - “ALL” for full scan; “BAND” for band scan, “PROG-xx (or scan name if programmed)” for programmed scan (xx= 0 to 24; programmed scan edges numbers are only displayed), “DUP” for duplex scan.
- ➔ To start the scan, release **[SCAN](2)**.
  - Scan pauses when a signal is received.
  - Rotate **[DIAL]** to change the scanning direction, or resumes manually.

② When scan pauses and you want to set the paused frequency as a skip frequency.

- ➔ Push and hold **[SKIP](5)** for 1 sec. to store the paused frequency into the highest blank memory channel.
  - While pushing and holding **[SKIP](5)**, rotate **[DIAL]** to select a skip condition from “SKIP,” “P SKIP” and “OFF.”
  - While pushing and holding **[SKIP](5)**, scan pauses; and after writing the frequency, scan resumes.

## ■ Scan resume condition

### ◇ Scan pause timer

The scan pauses when receiving signals according to the scan pause time. It can be set from 2 to 20 sec. or unlimited.

- ① Enter "PAUSE" in scan set mode. (p. 96)

⟨MENU screen⟩ ⇄ ⟨SCAN⟩ ⇄ ⟨PAUSE⟩  
(Push [MENU/LOCK]) (Rotate [DIAL]<sup>†</sup>, then push [↵](5)<sup>†</sup>.)

- ② Rotate [DIAL]<sup>†</sup> to set the desired scan pausing time from 2–20 sec. (2 sec. steps) or "HOLD."  
 • "2SEC"–"20SEC": Scan pauses for 2–20 sec. while receiving a signal.  
 • "HOLD" : Scan pauses on a received a signal until it disappears.
- ③ Push [↵](5) (or [←](4)) to return to scan set mode.  
 ④ [MENU/LOCK] to return to frequency indication.

#### • Pause timer setting

```

PAUSE TIMER
 4SEC
 6SEC
 8SEC
▼ 10SEC
 12SEC
  
```

### ◇ Scan resume timer

The scan restarts after the signal disappears according to the resume time. It can be set from 0–5 sec. or unlimited.

- ① Enter "RESUME" in scan set mode. (p. 96)

⟨MENU screen⟩ ⇄ ⟨SCAN⟩ ⇄ ⟨RESUME⟩  
(Push [MENU/LOCK]) (Rotate [DIAL]<sup>†</sup>, then push [↵](5)<sup>†</sup>.)

- ② Rotate [DIAL]<sup>†</sup> to set the desired scan resume time from 0–5 sec. (1 sec. steps) and "HOLD."  
 • "0SEC" : Scan restarts immediately after the signal disappears.  
 • "1SEC"–"5SEC" : Scan restarts 1–5 sec. after the signal disappears.  
 • "HOLD" : Scan restarts by rotating [DIAL] only.
- ③ Push [↵](5) (or [←](4)) to return to scan set mode.  
 ④ [MENU/LOCK] to return to frequency indication.

#### • Resume timer setting

```

RESUME TIMER
 1 SEC
▼ 2 SEC
 3 SEC
 4 SEC
 5 SEC
  
```

/// Scan resume timer must be set shorter than the scan pause timer, otherwise this timer does not activate.

<sup>†</sup>[DIAL] ⇄ [▲](2)/[▼](8)

[↵](5) ⇄ [▶](6)

# 10 PRIORITY WATCH

## Priority watch types

Priority watch checks for signals on the frequency every 5 sec. while operating on a VFO frequency or scanning. The transceiver has 3 priority watch types to suit your needs.

The watch resumes according to the selected scan resume condition. See page 81 for details.

**NOTE:** If the pocket beep function is activated, the transceiver automatically selects the tone squelch function when priority watch starts.

### About priority beep function

When receiving a signal on the priority frequency, you can be alerted with beeps and a blink “(•).” This function can be activated when setting the priority watch function ON.

### MEMORY/CALL CHANNEL WATCH

While operating on a VFO frequency, priority watch checks for a signal on the selected every 5 sec.

- A memory channel with skip information can be watched.

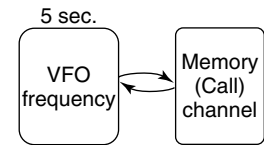

### MEMORY SCAN WATCH

While operating on a VFO frequency, priority watch checks for signals on each memory channel in sequence.

- The memory skip function and/or memory bank scan is useful to speed up the scan.

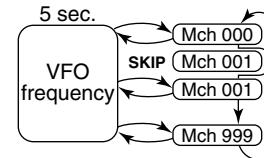

### VFO SCAN WATCH

While scanning in VFO mode, priority watch checks for signals on the selected every 5 sec.





## ■ Priority watch operation

Although [DIAL] and [↵](5) are used for description in this section, [▲](2)/[▼](8) and [▶](6) are available instead of [DIAL] and [↵](5).

### ◆ Memory/call channel and memory scan watch

- ① Select VFO mode; then, set an operating frequency.
- ② Set the watching channel(s).
  - For memory channel watch:**  
Select the desired memory channel.
  - For call channel watch:**  
Select the desired call channel.
  - For memory scan watch:**  
Select memory mode, or the desired bank group; then, push and hold [SCAN](2) for 1 sec. to start memory/bank scan.
- ③ Enter "PRIO WATCH" in scan set mode. (p. 96)
 

◀MENU screen▶ ↔ ▶SCAN▶ ↔ ▶PRIO WATCH▶  
 (Push [MENU/LOCK]) (Rotate [DIAL]†, then push [↵](5)†.)
- ④ Rotate [DIAL]† to select "ON."
  - Select "BELL" if the priority beep function is desired.
- ⑤ Push [MENU/LOCK] to exit scan set mode and start the watch.
  - "PRIO" indicator appears.
  - The transceiver checks the memory/bank channel(s) or call channel every 5 sec.
  - The watch resumes according to the selected scan resume condition. (p. 81)
- ⑥ Push [VFO] to cancel the watch.

### • During priority watch

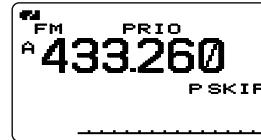

Monitors VFO frequency for 5 sec.

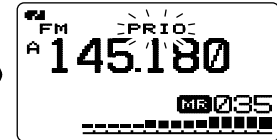

Pauses on a memory or call channel when a signal is received.

### • During priority watch with priority beep

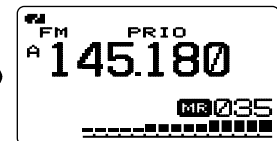
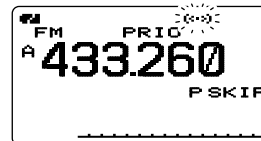

Emits beep and blinks "(•)" indicator when a signal is received on a memory or call channel.

†[DIAL] ↔ [▲](2)/[▼](8)

[↵](5) ↔ [▶](6)

## 10 PRIORITY WATCH

### ◆ VFO scan watch

- ① Set the watching channel(s).

**For memory channel watch:**

Select the desired memory channel.

**For call channel watch:**

Select the desired call channel.

**For memory scan watch:**

Select memory mode, or the desired bank group; then, push and hold **[SCAN](2)** for 1 sec. to start memory/bank scan.

- ② Enter "PRIO WATCH" in scan set mode. (p. 96)

◀MENU screen▶ ↔ ▶SCAN▶ ↔ ▶PRIO WATCH▶  
(Push **[MENU/LOCK]**) (Rotate **[DIAL]**†, then push **[↵](5)**†.)

- ③ Rotate **[DIAL]**† to select "ON."

- Select "BELL" if the priority beep function is desired.

- ④ Push **[VFO]** to exit scan set mode and start the watch.

- "PRIO" indicator appears.

- ⑤ Push and hold **[SCAN](2)** for 1 sec. to enter scan type selection condition.

- ⑥ Rotate **[DIAL]** to select the desired scan type from "ALL," "BAND" and "PROG-xx (xx= 0–24)," "DUP."

- ⑦ Release **[SCAN](2)** to start the VFO scan watch.

- The transceiver checks the memory/bank channel(s) or call channel every 5 sec.
- The watch resumes according to the selected scan resume condition. (p. 81)

- ⑧ Push **[VFO]** to cancel the watch.

• During priority watch

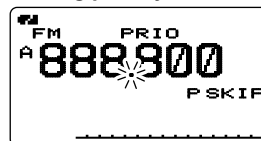

Searches VFO frequencies for 5 sec.

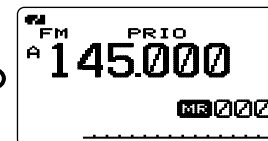

Pauses on a memory or call channel when a signal is received.

• During priority watch with priority beep

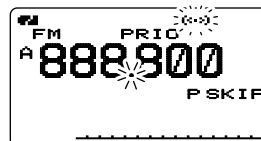

Emits beep and blinks "((•))" indicator when a signal is received on a memory or call channel.

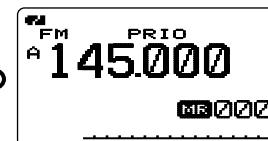

†**[DIAL]** ↔ **[▲](2)**/**[▼](8)**

**[↵](5)** ↔ **[▶](6)**

## ■ General

MENU screen is used for programming infrequently changed values or conditions of functions.

### ◇ Entering MENU screen and operation

e.g.) Set "AUTO power OFF" to 30 minutes.

① Push **[MENU/LOCK]** to enter MENU screen.

- MENU groups appear.

```
***** MENU *****
▶SET MODE
SCAN
DUP/TONE...
DISPLAY
SOUNDS
```

② Rotate **[DIAL]**<sup>†</sup> to select the desired menu group, then push **[↵](5)**<sup>†</sup>.

- Setting items appear.

```
SET MODE
▶AP OFF
POWER SAVE
ATTENUATOR
MONITOR
DIAL SPEED
```

③ Rotate **[DIAL]**<sup>†</sup> to select the desired item, then push **[↵](5)**<sup>†</sup>.

```
AUTO POWER OFF
▶OFF
30MIN
60MIN
90MIN
120MIN
```

④ Rotate **[DIAL]**<sup>†</sup> to select the desired value or condition, then push **[↵](5)** to return to the setting item selection mode.

```
AUTO POWER OFF
OFF
▶30MIN
60MIN
90MIN
120MIN
```

⑤ Push **[MENU/LOCK]** to return to frequency indication, repeat steps ② to ④ to set another items.

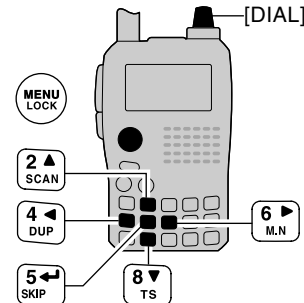

<sup>†</sup>[DIAL] ↔ [▲](2)/[▼](8)

[↵](5) ↔ [▶](6)

## 11 MENU SCREEN OPERATION

### ■ MENU screen indication for B band\*

While B band is selected, MENU screen shows following indication.

```
***** MENU *****  
RX CALL S  
MESSAGE/POS  
DV VOICE M  
=SET MODE  
DV SET MODE
```

MENU screen indication for B band.

\*The optional UT-121 is required.

### ■ Menu list

MENU	REF.	MENU	REF.
CALL SIGN†	—	DV SET MODE	pgs. 92–95
RX CALL SIGN†	—	SCAN	pgs. 96, 97
MESSAGE/POSITION†	—	DUP/TONE...	pgs. 97–99
DV VOICE MEMO†	—	DISPLAY	pgs. 99–101
SET MODE	pgs. 88–91	SOUNDS	p. 102

†Refer to the chapter 7 for details.

### ■ Items list

#### ◇ Set mode

ITEMS	REF.	ITEMS	REF.
AUTO POWER OFF	p. 88	AUTO POWER ON	p. 89
POWER SAVE	p. 88	LOCK	p. 90
ATTENUATOR	p. 88	PTT LOCK	p. 90
MONITOR	p. 89	BUSY LOCKOUT	p. 90
DIAL SPEED-UP	p. 89	TIME-OUT TIMER	p. 90
MIC SIMPLE MODE	p. 89	ACTIVE BAND	p. 91

◇ **DV set mode**

Available for B band when the UT-121 is installed.

ITEMS	REF.	ITEMS	REF.
AUTO REPLY	p. 92	GPS MODE	p. 94
DIGITAL CODE	p. 92	↳ GPS SENTENCE	p. 94
DV DATA TX	p. 92	↳ RMC SENTENCE	p. 94
DIGITAL MONITOR	p. 93	GGA SENTENCE	p. 94
DIGITAL RPT SET	p. 93	GLL SENTENCE	p. 94
RXCALL WRITE	p. 93	GSA SENTENCE	p. 94
RXRPT WRITE	p. 93	VTG SENTENCE	p. 94
		GPS AUTO TX	p. 95
		DV AUTO DETECT	p. 95
		EDIT RECORD	p. 95

◇ **Scan set mode**

ITEMS	REF.	ITEMS	REF.
PRIO WATCH‡	p. 96	BANK LINK	p. 97
PAUSE TIMER	p. 96	↳ BANK-A	p. 97
RESUME TIMER	p. 96		

‡Not available during the TV band selection.

◇ **DUP/TONE set mode**

Not available for the TV band selection.

ITEMS	REF.	ITEMS	REF.
OFFSET FREQ	p. 97	DTCS CODE	p. 98
REPEATER TONE	p. 97	DTCS POLARITY	p. 99
CTCSS TONE	p. 98	DTMF SPEED	p. 99

◇ **DISPLAY set mode**

ITEMS	REF.	ITEMS	REF.
BACKLIGHT	p. 99	SCAN NAME	p. 101
BUSY LED	p. 99	OPENING LOGO	p. 101
LCD CONTRAST	p. 100	OPENING CALL S*2	p. 101
RX CALL SIGN*1	p. 100	FONT SIZE	p. 101
TX CALL SIGN*1	p. 100		
RX MESSAGE*1	p. 100		

\*1Available for B band when the UT-121 is installed.

\*2Available when the UT-121 is installed.

◇ **SOUNDS set mode**

ITEMS	REF.	ITEMS	REF.
BEEP LEVEL	p. 102	SCOPE AF OUTPUT	p. 102
KEY-TOUCH BEEP	p. 102	VOLUME SELECT	p. 102
SCAN STOP BEEP	p. 102	STANDBY BEEP*1	p. 102

\*1Available for B band when the UT-121 is installed.

## ■ Set mode items

### ◇ Auto power OFF

The transceiver can be set to automatically turn OFF after a specified time period with a beep when no key operations are performed.

30 min., 60 min, 90 min, 120 min and OFF (default) can be specified. The specified time period is retained even when the transceiver is turned OFF by the auto power OFF function. To cancel the function, select "OFF" in this item.

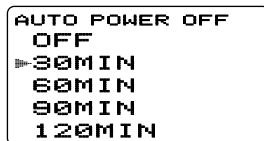
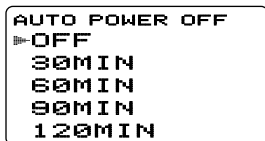

### ◇ Power save

The power save function reduces the current drain to conserve battery power. This power save function can be turned OFF, if desired, by turning power ON and OFF.

In the default setting ("AUTO" selection), the power save function is activated in a 1:1 (150 msec.: 150 msec.) ratio when no signal is received for 5 sec. The ratio becomes 1:4 (150 msec.: 600 msec.) when no signal is received for another 60 sec. Then the ratio becomes 1:8 (150 msec.: 1200 msec.) when no signal is received for another more 60 sec.

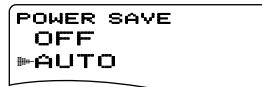

### ◇ Attenuator

The attenuator prevents distortion of a desired signal by very strong RF signals near the desired frequency or when very strong electric fields, such as from a broadcasting station, are present at your location.

Select the attenuator function ON and OFF (default).



◆ **Monitor key action**

The monitor key, [SQL], can be set as a 'sticky' key. When set to the sticky condition, each push of [SQL] toggles the monitor function ON and OFF.

- PUSH: Pushing and holding [SQL] to monitor the frequency. (default)
- HOLD: Push [SQL] momentarily to monitor the frequency and push momentarily again to cancel it.



◆ **Dial speed acceleration**

The dial speed acceleration automatically speeds up the tuning dial speed when rotating [DIAL] rapidly.

- OFF : The dial speed acceleration is turned OFF.
- ON : The dial speed acceleration is tuned ON. (default)



◆ **Microphone simple mode**

Microphone simple mode is used to change the function assignments for keys on the optional HM-75A REMOTE CONTROL SPEAKER-MICROPHONE. (pgs. 121, 123)

- SIMPLE
- NORM-1 (default)
- NORM-2



◆ **Auto power ON**

Auto power ON function turns the transceiver power ON automatically after passing the set time period from power OFF. Select the desired time period within 30 minutes to 24 hours in 30 minutes steps and OFF. (default: OFF)



# 11 MENU SCREEN OPERATION

## ◇ Key lock Type

While the key lock function is ON, [PWR], [PTT], [SQL], [VOL] and [MENU] (Lock function only) can still be accessed. Accessible keys can be set to 1 of 4 groups.

- NORMAL : [PWR], [PTT], [SQL], [VOL] and [MENU] (Lock function only) accessible. (default)
- NO SQL : [PWR], [PTT], [SQL], and [MENU] (Lock function only) are accessible.
- NO VOL : [PWR], [PTT], [VOL], and [MENU] (Lock function only) are accessible.
- ALL : [PWR], [PTT] and [MENU] (Lock function only) are accessible.

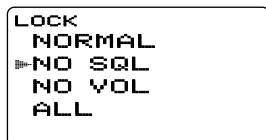
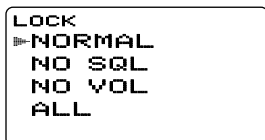

## ◇ PTT lock

Turns the PTT lock function ON and OFF. Transmission with [PTT] is inhibited when ON is selected to prevent accidental transmission, etc. (default: OFF)



## ◇ Busy lockout

Turns the busy lockout function ON and OFF. This function inhibits transmission while receiving a signal or when the squelch is open. (default: OFF)



## ◇ Time-out timer

To prevent accidental prolonged transmission, etc., the transceiver has a time-out timer. This function cuts a transmission OFF after 1, 3, 5 or 10 min. of continuous transmission. This timer can be cancelled.

- OFF : The time-out timer is turned OFF. (default)
- 1 to 10 MIN : The transmission is cut OFF after the set period elapses.

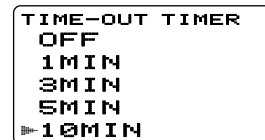
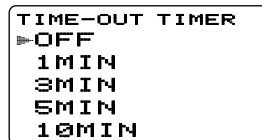



### ◇ Active band

Allows continuous frequency selection of the operating frequency across all bands.

- SINGLE : A single operating frequency can be selected within the current band. Push **[BAND]** for band selection in this case.
- ALL : The operating frequency can be selected continuously. (default)



ACTIVE BAND  
SINGLE  
▶ALL



ACTIVE BAND  
▶SINGLE  
ALL

## 11 MENU SCREEN OPERATION

### ■ DV set mode items

The following items are selectable when the optional UT-121 is installed.

#### ◇ Auto reply

This function replies to an individual station call even you are away from the transceiver.

After a manual transmission (pushing **[PTT]**), the Auto Reply setting returns to OFF automatically.

- OFF : No reply is performed even a call is received. (default)
- ON : Sets caller's call sign and reply to the call with the set own call sign automatically.
- VOICE : Sets caller's call sign and reply to the call with the recorded audio in REPLY VOICE memory of DV VOICE MEMO.

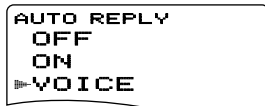

/// **NOTE:** When "ON" or "VOICE" is set to the auto reply function, the power save function (p. 88) is turned OFF automatically to receive call sign signal properly.

#### ◇ Digital code

Sets the desired digital code for digital code squelch operation. Total of 100 codes (00–99) are available. (default: 00)



#### ◇ DV data TX

During low-speed data operation, auto data transmission function is available. This function transmits when data has been input from PC via the **[DATA]** jack. (default: PTT)

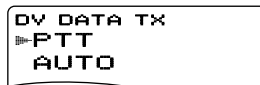

### ◆ Digital monitor

Sets the desired monitoring mode during digital mode operation from “Auto,” “Digital” and “Analog.”

- **AUTO** : The transceiver sets monitoring mode to FM and DV according to the received signal. (default)
- **DIGITAL** : Monitors in DV mode.
- **ANALOG** : Monitors in FM mode.



### ◆ Digital repeater setting

When accessing a digital repeater with a call sign different than is programmed, the repeater call sign can be stored into “RPT1” and/or “RPT2” automatically by reading the repeater’s transmission. The stored repeater’s call sign can be re-called when selecting the repeater call sign. (default: ON)



### ◆ RX call sign auto write

When an individual station call is received, the calling station call sign can be automatically set in “UR.” (default: OFF)

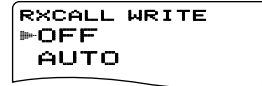

### ◆ Repeater call sign auto write

When accessing a repeater with a call sign different than is programmed, the repeater call sign can be set into “RPT1” and/or “RPT2” automatically by reading the repeater’s transmission. (default: OFF)

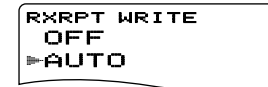
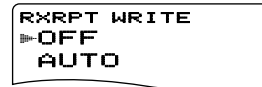

/// The transceiver sets the received repeater call sign for operation. Therefore, when a different call sign is set for operation, the previously set repeater call sign will be lost.

# 11 MENU SCREEN OPERATION

## ◆ GPS mode

Sets GPS mode operation ON and OFF.

When the position information is received from a connected GPS receiver and the GPS Auto TX Timer setting (p. 95) is set to a specific time, the transceiver automatically transmits with the current position and message at every setting interval. (default: OFF)

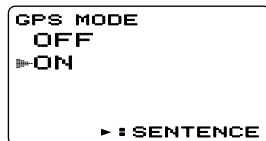
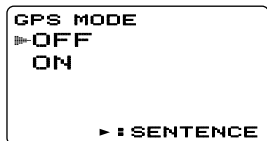

## • Sentence formatter setting

- ① Select "ON" in GPS mode item, then push [**↵**](5)<sup>†</sup> to enter the sentence formatter selection.
- ② Rotate [**DIAL**]<sup>†</sup> to select the desired sentence formatter.
  - RMC, GGA, GLL, GSA and VTG are selectable.

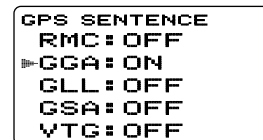
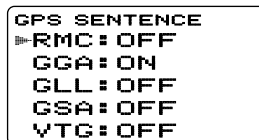

- ③ Push [**↵**](5)<sup>†</sup> to enter the desired sentence formatter selection.
- ④ Rotate [**DIAL**]<sup>†</sup> to select the setting.



- ⑤ Rotate [**DIAL**]<sup>†</sup> to select next sentence and repeat steps ② to ④, or push [**MENU/LOCK**] to return to frequency indication.
  - Only three sentence formatters can be activated at same time.

<sup>†</sup>[DIAL] ↔ [▲](2)/[▼](8)

[↵](5) ↔ [▶](6)

◆ **GPS auto TX timer**

Selects the desired interval for automatic position transmission function from 5, 10, 30 second, 1, 3, 5, 10, 30 minutes and OFF. (default: OFF)

- The position data is transmitted manually (with [PTT]) when "OFF" is selected.

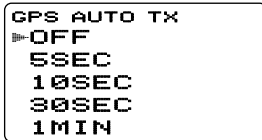

◆ **DV auto detect**

When a signal other than DV mode is received during DV mode operation, the transceiver has capability of automatic FM mode selection.

- OFF : Operating mode is fixed in DV. (default)
- ON : The transceiver automatically selects FM mode for temporary operation.



◆ **Call sign edit record**

Selects the call sign programming when the call sign is edited or corrected with the pre-programmed call sign.

- OFF : The edited or corrected call sign is over written.
- SELECT : The edited or corrected call sign is programmed into the selected call sign memory.
- AUTO : The edited or corrected call sign is programmed into a blank channel automatically. (default)



## ■ Scan set mode items

### ◇ Priority watch

Activates priority watch or priority watch with alert (Bell).

- OFF : The priority watch is turned OFF. (default)
- ON : The transceiver checks the memory channel frequency every 5 sec.
- BELL : The transceiver checks the memory channel frequency every 5 sec. You can be alerted with beeps and blinking “(••).”



### ◇ Scan pause timer

Selects the scan pause time. When receiving signals, the scan pauses according to the scan pause time.

- 2–20 SEC : Scan pauses for 2–20 sec. on a received signal in 2 sec. steps. (default: 10 sec.)
- HOLD : Scan pauses on a received signal until it disappears. Rotate [DIAL] to resume manually.

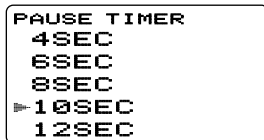

### ◇ Scan resume timer

Selects the scan resume time from a paused frequency after the received signal disappears.

- 0 : Scan resumes when a received signal disappears.
- 1–5 SEC : Scan pauses 1–5 sec. after a received signal disappears. (default: 2 sec.)
- HOLD : Scan pauses on the received signal even if it disappears. Rotate [DIAL]† to resume manually.



/// Scan resume timer must be set shorter than scan pause timer (previous item), otherwise this timer does not activate.

### ◇ Memory bank link function

Sets the memory bank link function ON (default) and OFF. The link function provides continuous bank scan, scanning all contents in the selected banks during bank scan.

#### • Bank link setting

- ① Rotate [DIAL]<sup>†</sup> to select the bank that you want to change.

```
BANK LINK
▶BANK-A: ON
  BANK-B: ON
  BANK-C: ON
  BANK-D: ON
  BANK-E: ON
```

```
BANK LINK
  BANK-V: ON
  BANK-W: ON
  BANK-X: ON
  BANK-Y: ON
▶BANK-Z: ON
```

- ② Push [↵](5)<sup>†</sup> to enter bank setting.  
 ③ Rotate [DIAL]<sup>†</sup> to select the setting.

```
BANK-A
  OFF
▶ON
```

```
BANK-A
▶OFF
  ON
```

- ④ Push [↵](5)<sup>†</sup> to set and return to the BANK LINK screen.  
 ⑤ Rotate [DIAL]<sup>†</sup> to select next bank and repeat steps ② to ④, or push [MENU/LOCK] to exit scan set mode.

<sup>†</sup>[DIAL] ↔ [▲](2)/[▼](8)

[↵](5) ↔ [▶](6)

## ■ DUP/TONE set mode items

### ◇ Offset frequency

Sets the offset frequency for duplex (repeater) operation within 0 to 159.995 MHz range.

```
OFFSET FREQ
  0. 000. 00
```

```
OFFSET FREQ
 159. 995. 00
```

The default value may differ according to the selected frequency band (before accessing DUP/TONE set mode) and transceiver version.

/// The selected tuning step in VFO mode is used for setting the offset frequency.

### ◇ Repeater tone frequency

Selects subaudible tone frequency for accessing a repeater, etc. Total of 50 tone frequencies (67.0–254.1 Hz) are available. (default: 88.5)

```
REPEATER TONE
  88. 5
```

```
REPEATER TONE
 254. 1
```

# 11 MENU SCREEN OPERATION

## ◆ TSQL frequency

Selects tone frequency for tone squelch or pocket beep operation from one of 50 available frequencies (67.0–254.1 Hz).

(default: 88.5)

CTCSS TONE  
88.5

CTCSS TONE  
254.1

### • Available subaudible tone frequencies

67.0	79.7	94.8	110.9	131.8	156.7	171.3	186.2	203.5	229.1
69.3	82.5	97.4	114.8	136.5	159.8	173.8	189.9	206.5	233.6
71.9	85.4	100.0	118.8	141.3	162.2	177.3	192.8	210.7	241.8
74.4	88.5	103.5	123.0	146.2	165.5	179.9	196.6	218.1	250.3
77.0	91.5	107.2	127.3	151.4	167.9	183.5	199.5	225.7	254.1

/// The transceiver has 50 tone frequencies and consequently their spacing is narrow compared with units having 38 tones. Therefore, some tone frequencies may receive interference from adjacent tone frequencies.

## ◆ DTCS code

Selects DTCS (both encoder/decoder) code for DTCS squelch operation. Total of 104 codes (023–754) are available.

(default: 023)

DTCS CODE  
023

DTCS CODE  
754

### • Available DTCS codes

023	054	125	165	245	274	356	445	506	627	732
025	065	131	172	246	306	364	446	516	631	734
026	071	132	174	251	311	365	452	523	632	743
031	072	134	205	252	315	371	454	526	654	754
032	073	143	212	255	325	411	455	532	662	
036	074	145	223	261	331	412	462	546	664	
043	114	152	225	263	332	413	464	565	703	
047	115	155	226	265	343	423	465	606	712	
051	116	156	243	266	346	431	466	612	723	
053	122	162	244	271	351	432	503	624	731	



◆ **DTCS polarity**

Sets DTCS polarity from “BOTH N” (TX/RX: normal), “TN-RR” (TX: normal, RX: reverse), “TR-RN” (TX: reverse, RX: normal) and “BOTH R” (TX/RX: reverse). (default: BOTH N)

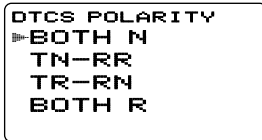

TX/RX: Normal polarity

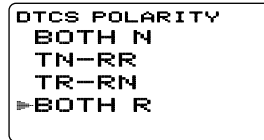

TX/RX: Reverse polarity

◆ **DTMF speed**

Select the desired DTMF transmission speed from 100 msec, 200 msec, 300 msec, 500 msec.

- 100 : 100 msec. interval; 5.0 characters per second (default)
- 200 : 200 msec. interval; 2.5 characters per second
- 300 : 300 msec. interval; 1.6 characters per second
- 500 : 500 msec. interval; 1.0 character per second

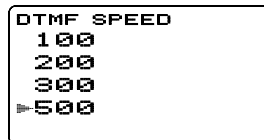
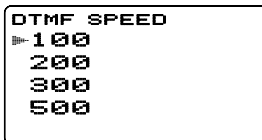

■ **Display set mode items**

◆ **Display backlighting**

The transceiver has display backlighting with a 5 sec. timer for night time operation. The display backlighting can be turned ON continuously or turned OFF, if desired.

- OFF : The backlight is turned OFF.
- ON : The backlight continuously lights ON.
- AUTO: Lights when an operation is performed, goes out after 5 sec. (default)  
 \*Continuously lights ON while operating with an external DC power source.



◆ **Busy LED**

The TX/RX indicator lights green while receiving a signal or when the squelch is open. This indication can be turned OFF to conserve the battery power, if desired.

- OFF : The indicator does not function even if a signal is received.
- ON : The indicator lights green while receiving a signal or when the squelch is open. (default)



# 11 MENU SCREEN OPERATION

## ◆ LCD contrast

The contrast of the LCD can be selected from 16 levels.

- 1 (Low contrast) to 16 (High contrast) (default: 8)



Default (8)



High contrast (16)

## ◆ RX Call Sign Display

☞ Available when the UT-121 is installed.

When a call is received, the calling station call sign can be indicated automatically. (default: AUTO)

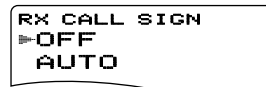

## ◆ TX Call Sign Display

☞ Available when the UT-121 is installed.

Selects call sign display function from YOUR, MY and OFF. When this setting is set to YOUR or MY, the transceiver automatically indicates the set station or your own call sign at digital mode transmission. (default: YOUR)



## ◆ RX message Display

☞ Available when the UT-121 is installed.

Sets auto received message display function AUTO and OFF. When this setting is set to AUTO, the transceiver automatically indicates and scrolls the received message. (default: AUTO)



◆ **Scan name**

The programmed scan or bank name is displayed during the scan type selection.

- ON : The programmed scan or bank name is displayed. (default)
- OFF : The programmed scan or bank name is not displayed.



◆ **Opening logo**

The opening logo indication (Icom logo and transceiver name) that is displayed at power ON can be skipped, if desired.

- ON : Opening logo is displayed at power ON. (default)
- OFF : Opening logo indication is skipped.



◆ **Opening call sign**

Available when the UT-121 is installed.

The set your own call sign, programmed in my call sign, can be displayed at power ON. (default: OFF)



◆ **Font size**

Displayed character size during MENU mode indication in the function display is selectable from Large and Small.

- LARGE : Makes 5 lines (Max. 5 items are displayed at the same time). (default)
- SMALL : Makes 6 lines (Max. 6 items are displayed at the same time).



# 11 MENU SCREEN OPERATION

## ■ Sounds set mode items

### ◇ Beep output level

Adjusts the key-touch beep tone level to the desired level within 39 levels.

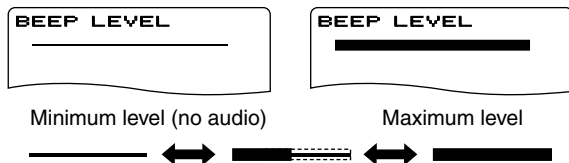

▨ The key-touch beep (following item) must be set to ON to have a beep tone.

### ◇ Key-touch beep

Turns the key-touch beep ON or OFF. (default: ON)

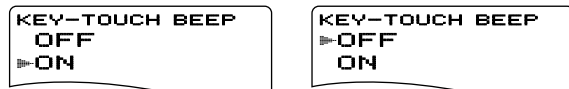

### ◇ Scan stop beep

Turns the scan stop beep function ON or OFF. (default: OFF)



### ◇ Scope audio output

Select the audio output capability during sweep with band scope function.

- ON : The received audio sounds during sweep. (default)
- OFF : No audio sounds during sweep.

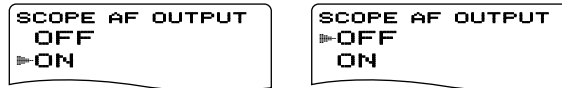

### ◇ Volume select

Select the volume level adjustment from Both and Separate for dualwatch operation.

- BOTH : Both A band and B band volume level is adjusted with [VOL] at the same time. (default)
- SEPARATE : The Volume setting is adjusted independently in A and B bands with [VOL].



### ◇ Standby Beep

☞ Available when the UT-121 is installed.

Turns the beep emission capability ON and OFF when the communicating station finishes transmitting or the receive signal disappears while in the digital mode operation. (default: ON)



## ■ Programming a DTMF code

DTMF codes are used for autopatching, accessing repeaters, controlling other equipment, etc. The transceiver has 10 DTMF memory channels (Ch01–Ch10) for storage of often-used DTMF codes of up to 16 digits.

- ① Push and hold **[DTMF.M](.)** for 1 sec. to enter DTMF memory.
- ② Rotate **[DIAL]**<sup>†</sup> to select the desired DTMF memory channel.
  - “T-CALL” appears when a 1750 Hz tone burst signal is selected. (p. 33)

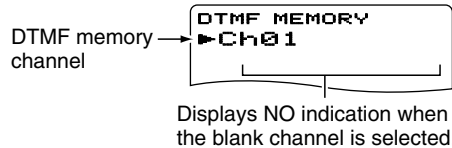

- ③ Push **[▶](6)** to enter programming mode.
  - Previously programmed DTMF code is displayed if programmed.

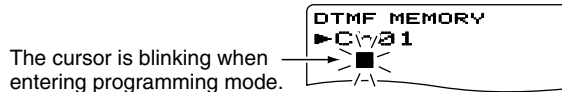

- ④ Push the desired keys to input the characters.
  - **[0]–[9]** input “0”–“9,” **[A](VFO)** inputs “A,” **[B](MR)** inputs “B,” **[C](CALL)** inputs “C,” **[D](BAND)** inputs “D,” **[#](.)** inputs “#” and **[\*](REC)** inputs “\*.”
  - Up to 16 digits can be programmed.
  - Push **[MAIN/DUAL]** to delete the cursor placed code.
  - Push and hold **[MAIN/DUAL]** for 1 sec. to delete the character at the cursor and all following characters.
- ⑤ Repeat step ④ until the desired code is input.

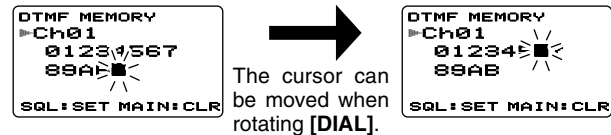

The display after 16th digit of channel 01 is input.

- ⑥ Push **[MENU/LOCK]** to program the DTMF code and exit programming mode.
  - Entering 16th digit automatically exits the programming mode.
- ⑦ Push **[VFO]** to exit DTMF memory.

### ■ Transmitting a DTMF code

#### ◇ Transmitting from DTMF memory

The selected DTMF code is transmitted at each push of the [SQL] switch while transmitting.

▨ The transmitting speed at which DTMF memories send individual DTMF characters can be set in "DTMF SPEED" menu. (p. 99)

- ① Set the desired frequency. (p. 18)
- ② Push and hold [DTMF.M](.) for 1 sec. to enter DTMF memory.
- ③ Rotate [DIAL]<sup>†</sup> to select the desired DTMF memory channel.
- ④ Push [↵](5) to set the DTMF memory.
- ⑤ Push [VFO] to exit DTMF memory.
- ⑥ While pushing [PTT], push [SQL] to transmit the selected DTMF code.

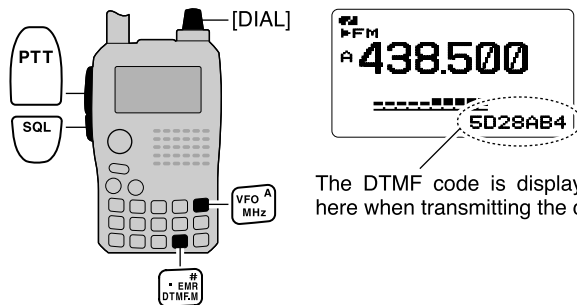

#### ◇ Transmitting a DTMF code directly

DTMF code can be transmitted via keypad directly while transmitting.

- ① Set the desired frequency. (p. 18)
- ② While pushing [PTT], push the desired keys to transmit the DTMF code.
  - [0]–[9] input "0"–"9," [A](VFO) inputs "A," [B](MR) inputs "B," [C](CALL) inputs "C," [D](BAND) inputs "D," [#](.) inputs "#" and [\*](REC) inputs "\*."

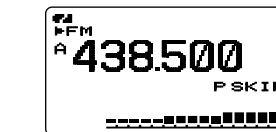
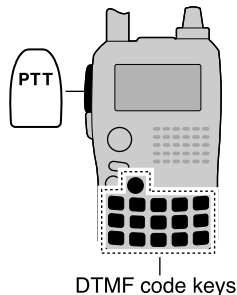

DTMF codes do not appear on the display when transmitting codes directly.

## ■ Clearing a DTMF memory

An unwanted DTMF memory can be cleared (erased).

- ① Push and hold **[DTMF.M](.)** for 1 sec. to enter DTMF memory mode.
- ② Rotate **[DIAL]**† to select the desired DTMF memory channel to be cleared.
- ③ Push and hold **[CLR](1)** for 1 sec. to clear the selected DTMF memory channel.

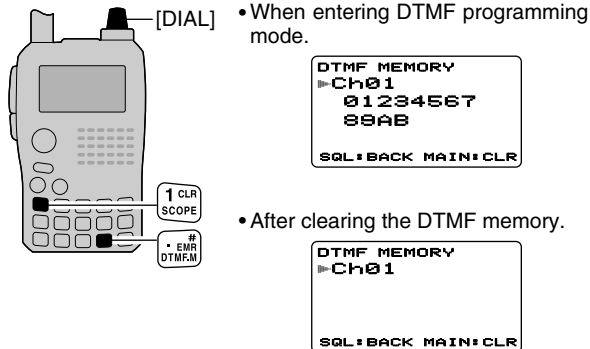

## ■ Confirming a DTMF memory

A DTMF memory can be confirmed with a DTMF tone.

- ① Push and hold **[DTMF.M](.)** for 1 sec. to enter DTMF memory mode.
- ② Rotate **[DIAL]**† to select the desired DTMF memory channel.
- ③ Push **[SQL]** to confirm the DTMF memory contents.

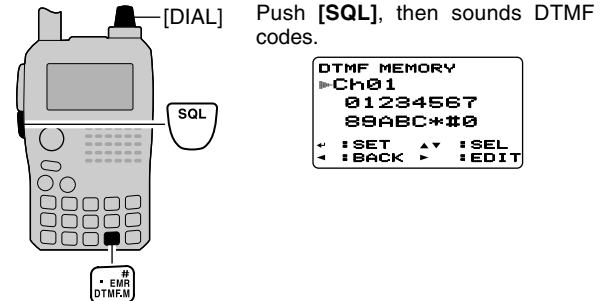

†[DIAL] ↔ [▲](2)/[▼](8)

### ■ Setting DTMF transfer speed

The DTMF transfer speed can be selected.

- ① Enter “DTMF SPEED” in DUP/TONE... set mode. (p. 99)

◀MENU screen▶ ↔ ▶DUP/TONE...▶ ↔ ▶DTMF SPEED▶  
(Push [MENU/LOCK]) (Rotate [DIAL]†, then push [↵](5)†.)

- ② Rotate [DIAL]† to select DTMF transfer speed as below.

100: Transfer the DTMF data per about 100 msec.

200: Transfer the DTMF data per about 200 msec.

300: Transfer the DTMF data per about 300 msec.

500: Transfer the DTMF data per about 500 msec.

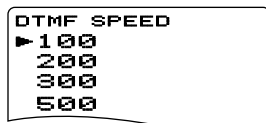

- ③ Push [↵](5) (or [←](4)) to return to DUP/TONE... set mode, and push [MENU/LOCK] to return to frequency indication.

### ■ Tone frequency and DTCS code

#### ◇ Subaudible (repeater) tone

Some repeaters require subaudible tones to be accessed. Subaudible tones are superimposed over your normal signal and must be set in advance.

#### ◇ Tone and DTCS squelches

The tone squelch (CTCSS) or DTCS squelch opens only when receiving a signal containing a matching subaudible tone or DTCS code, respectively. You can silently wait for calls from group members using the same tone or code. Separate tone frequencies can be set for repeater and tone squelch/pocket beep operation.

#### ◇ Pocket beep

These functions use subaudible tones or DTCS codes for calling and can be used as a “common pager” to inform you that someone has called while you were away from the transceiver.

†[DIAL] ↔ [▲](2)/[▼](8)

[↵](5) ↔ [▶](6)



### ◇ Setting subaudible tones for repeater or tone squelch

- ① Enter “CTCSS TONE (or RPT TONE)” in DUP/TONE... set mode. (pgs. 97, 98)  
 <MENU screen> ⇄ <DUP/TONE...> ⇄ <CTCSS TONE>  
 (Push [MENU/LOCK]) (Rotate [DIAL]†, then push [↵](5)†.)
- ② Rotate [DIAL]† to select the desired repeater or CTCSS tone frequency.
  - Each operating band and each memory channel have independent settings.
  - See page 98 for available tone frequencies for details.
- ③ Push [↵](5) (or [←](4)) to return to DUP/TONE... set mode, and push [MENU/LOCK] to return to frequency indication.

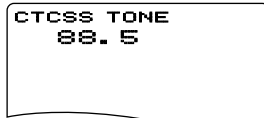

### ◇ Setting DTCS code for DTCS squelch or beep

- ① Enter “DTCS CODE” in DUP/TONE... set mode. (p. 98)  
 <MENU screen> ⇄ <DUP/TONE...> ⇄ <DTCS TONE>  
 (Push [MENU/LOCK]) (Rotate [DIAL]†, then push [↵](5)†.)
- ② Rotate [DIAL]† to select the desired DTCS tone code.
  - Each operating band and each memory channel have independent settings.
  - See page 98 for available DTCS codes for details.
- ③ Push [↵](5) (or [←](4)) to return to DUP/TONE... set mode, and push [MENU/LOCK] to return to frequency indication.



▨ DTCS phase mode can be selected in “DTCS POLARITY” menu. (p. 99)

## ■ Digital code and digital call sign setting

*The optional UT-121 is required*

### ◇ Setting digital code for digital code squelch or beep

- ① Push [MAIN/DUAL] to select B band, then push and hold [MODE](REC) for 1 sec. several times to select DV mode.
- ② Enter "DIGITAL CODE" in DV SET MODE. (p. 92)

◀MENU screen▶ ↔ ▶DV SET MODE▶ ↔ ▶DIGITAL CODE▶  
(Push [MENU/LOCK]) (Rotate [DIAL]†, then push [↵](5)†.)

- ③ Rotate [DIAL]† to select the desired digital code.
  - Each operating band and each memory channel have independent settings.

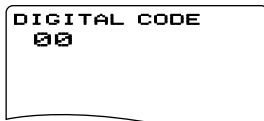

- ④ Push [↵](5) (or [◀](4)) to return to DV SET MODE, and push [MENU/LOCK] to return to frequency indication.

### ◇ Setting the YOUR and MY call signs for digital call sign squelch or beep

- ① Push [MAIN/DUAL] to select B band, then push and hold [MODE](REC) for 1 sec. several times to select DV mode.
- ② Enter "YOUR CALL SIGN" in CALL SIGN set mode. (p. 36)

◀MENU screen▶ ↔ ▶CALL SIGN▶ ↔ ▶YOUR CALL SIGN▶  
(Push [MENU/LOCK]) (Rotate [DIAL]†, then push [↵](5)†.)

- ③ Rotate [DIAL]† to select the desired call sign.
  - Input the call sign if the desired call sign is not stored in the transceiver. See p. 36 for detail.

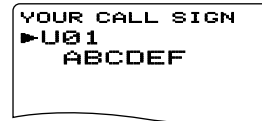

- ④ Push [↵](5) (or [◀](4)) to return to CALL SIGN set mode.
- ⑤ Rotate [DIAL]† to select "MY CALL SIGN" in CALL SIGN set mode, then push [↵](5)† to enter "MY CALL SIGN" setting.

◀MENU screen▶ ↔ ▶CALL SIGN▶ ↔ ▶MY CALL SIGN▶  
(Push [MENU/LOCK]) (Rotate [DIAL]†, then push [↵](5)†.)

†[DIAL] ↔ [▲](2)/[▼](8)

[↵](5) ↔ [▶](6)

- ⑥ Rotate **[DIAL]**<sup>†</sup> to select the desired call sign.
- Input the call sign if the desired call sign is not stored in the transceiver. See pgs. 34 and 35 for detail.

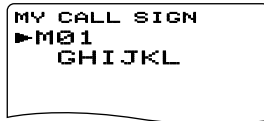

MY CALL SIGN  
▶M01  
GHIJKL

- ⑦ Push **[↵](5)** to set call sign and push **[MENU/LOCK]** to return to frequency indication.

**CAUTION!** Use digital code squelch when operating with more than 3 stations. Because the digital call sign squelch function recognizes “**MY CALL SIGN**,” the digital call sign squelch function can be used when operating with only one station.

**NOTE:**

- The tone/DTCS code squelch opens sometimes when other stations communicate with adjacent tone frequency or DTCS code.

<sup>†</sup>[DIAL] ↔ [▲](2)/[▼](8)

[↵](5) ↔ [▶](6)

## ■ Tone/DTCS squelch

- ① Set the desired operating frequency, CTCSS tone and DTCS code.
- ② Push and hold **[TONE](7)** for 1 sec. several times to activate the tone or DTCS squelch. (TONE, TSQL or DTCS)
  - Subaudible tone encoder “TONE,” tone squelch “TSQL,” pocket beep “TSQL ((·)),” DTCS squelch “DTCS,” DTCS beep “DTCS ((·))” and no tone operation are activated in order.
  - Rotating **[DIAL]** while pushing **[TONE](7)** also selects the tone functions.
- ③ Operate the transceiver in the normal way.
- ④ When the received signal includes a matching tone/code, the squelch opens and the signal can be heard.
  - When the received signal’s tone/code does not match, tone/DTCS squelch does not open, however, the S-indicator shows signal strength.
  - To open the squelch manually, push and hold **[SQL]**.

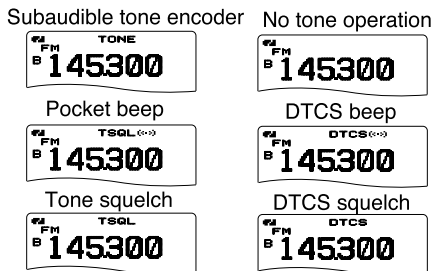

## ■ Digital code/digital call sign squelch

The optional UT-121 is required

- ① Set the desired operating frequency on DV mode, Digital code and MY CALL SIGN.
- ② Push and hold **[DSQ](7)** for 1 sec. several times to activate the digital code or digital call sign squelch. (DSQL or CSQL)
  - Digital call sign squelch “DSQL,” Digital call sign beep “DSQL ((·))”, Digital code squelch “CSQL,” Digital code beep “CSQL ((·))” and no tone operation are activated in order.
  - Rotating **[DIAL]** while pushing **[DSQ](7)** also selects the tone functions.
- ③ Operate the transceiver in the normal way.
- ④ When the received signal includes a matching call sign/code, the squelch opens and the signal can be heard.
  - When the received signal’s call sign/code does not match, digital call sign/digital code squelch does not open, however, the S-indicator shows signal strength.
  - To open the squelch manually, push and hold **[SQL]**.

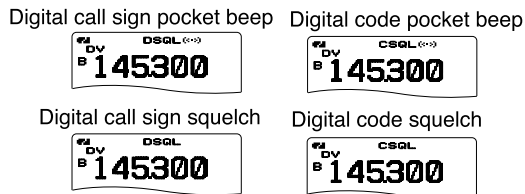

## ■ Pocket beep function

- ① Set the desired operating frequency.
- ② Set the desired CTCSS tone, DTCS code, Digital call sign or Digital code.
- ③ Push and hold **[TONE](7)/[DSQ](7)** for 1 sec. several times to activate the pocket beep, DTCS beep, Digital call sign beep or Digital code beep. (“TSQL ((·))”, “DTCS ((·))”, “DSQL ((·))” or “CSQL ((·))”)
  - Rotating **[DIAL]** while pushing **[TONE](7)/[DSQ](7)** also selects the tone functions.

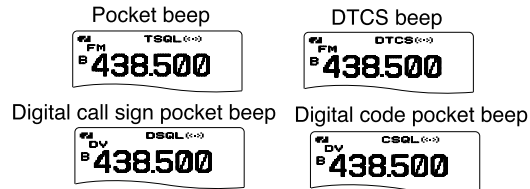

- ④ When a signal with the correct tone, code, digital call sign or digital code is received, the transceiver emits beep tones for 30 sec. and blinks “((·)).”
- ⑤ Push **[PTT]** to answer or push **[SQL]** to stop the beeps and blinking.

## ■ DTCS polarity setting

- ① Enter “DTCS P” in DUP/TONE... set mode. (p. 99)

<MENU screen> → <DUP/TONE...> → <DTCS P>  
 (Push **[MENU/LOCK]**) (Rotate **[DIAL]**<sup>†</sup>, then push **[J](5)**<sup>†</sup>.)

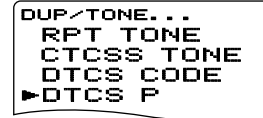

- ② Rotate **[DIAL]**<sup>†</sup> to select the desired DTCS polarity mode.
  - BOTH N: Normal phase is used for both TX and RX. (Default)
  - TN-RR: Normal phase is used for TX; Reverse phase for RX.
  - TR-RN: Reverse phase is used for TX; Normal phase for RX.
  - BOTH R: Reverse phase is used for both TX and RX.
- ③ Push **[J](5)** (or **[4](4)**) to return to DUP/TONE... set mode, and push **[MENU/LOCK]** to return to frequency indication.

## 12 OTHER FUNCTIONS

### ■ Tone scan

The transceiver can detect the subaudible tone frequency and DTCS code in a received signal. By monitoring a signal that is being transmitted on a repeater input frequency, you can determine the tone frequency required to access the repeater.

- ① Set the desired frequency or memory channel to be checked for a tone frequency or DTCS code.
- ② Push and hold **[TONE](7)** for 1 sec. several times to activate the repeater tone, tone squelch or DTCS squelch. (TONE, TSQL or DTCS)
  - Rotating **[DIAL]** while pushing and holding **[TONE](7)** also selects the tone functions.
- ③ Push and hold **[T.SCAN](9)** for 1 sec. to start the tone scan.
  - To change the scanning direction, rotate **[DIAL]**.
- ④ When the tone frequency or DTCS code is decoded, the set mode contents are programmed with the frequency or code.
  - The tone scan pauses for the set period in scan pause timer (p. 96) when a tone frequency or DTCS code is detected.
  - The decoded tone frequency is used for the repeater tone frequency when the tone squelch is OFF.
  - The decoded tone frequency is used for the tone squelch frequency (CTCSS TONE) when the tone squelch is ON.
  - The decoded DTCS code is used for the DTCS code when the DTCS squelch is ON.

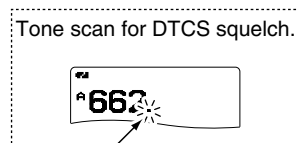
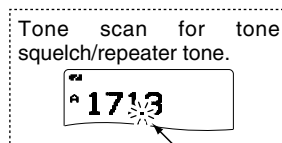
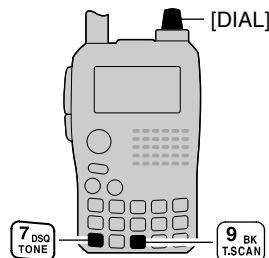

The decimal point is blinking while tone scanning.

- ⑤ Push **[VFO]** to stop the scan.
  - If the scan is cancelled before the transceiver detects the tone or code, the set mode contents are not changed.
  - The detected tone is temporary operation only. The stored tone setting in memory or call channel won't be changed.

## ■ Beep tones

You can select to have confirmation beeps sound at the push of a switch. The output level can be adjusted within 39 levels or to the related level of the volume with “BEEP LEVEL” in sounds set mode. (p. 102)

⟨MENU screen⟩ ⇄ ⟨SOUNDS⟩ ⇄ ⟨BEEP LEVEL⟩  
(Push [MENU/LOCK]) (Rotate [DIAL]†, then push [↵](5)†.)

You can select silent operation by turning beep tones OFF with “KEY-TOUCH BEEP” in sounds set mode. (p. 102)

⟨MENU screen⟩ ⇄ ⟨SOUNDS⟩ ⇄ ⟨KEY-TOUCH BEEP⟩  
(Push [MENU/LOCK]) (Rotate [DIAL]†, then push [↵](5)†.)

## ■ Dial speed acceleration

The dial speed acceleration automatically speeds up the tuning dial speed when rotating [DIAL] rapidly.

This function can be turned ON and OFF with “DIAL SPEED” in set mode. (p. 89)

⟨MENU screen⟩ ⇄ ⟨SET MODE⟩ ⇄ ⟨DIAL SPEED⟩  
(Push [MENU/LOCK]) (Rotate [DIAL]†, then push [↵](5)†.)

## ■ Key lock effect

### ◇ Lock function

The lock function prevents accidental frequency changes and accidental function access.

- Push [MENU/LOCK] for 1 sec. to toggle the lock function ON and OFF.
  - [PWR], [VOL], [SQL] and [PTT] can still be accessed while the lock function is ON. (default)

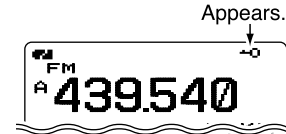

### ◇ Key lock type

While the lock function is ON, [PWR], [VOL], [SQL] and [PTT] can still be accessed. Accessible switches can be set to one of 4 groups with “LOCK” in set mode. (p. 90)

⟨MENU screen⟩ ⇄ ⟨SET MODE⟩ ⇄ ⟨LOCK⟩  
(Push [MENU/LOCK]) (Rotate [DIAL]†, then push [↵](5)†.)

- “NORMAL” : [PWR], [VOL], [SQL] and [PTT] are accessible.
- “NO SQL” : [PWR], [SQL] and [PTT] are accessible.
- “NO VOL” : [PWR], [VOL] and [PTT] are accessible.
- “ALL” : [PWR] and [PTT] are accessible.

†[DIAL] ↔ [▲](2)/[▼](8)

[↵](5) ↔ [▶](6)

## 12 OTHER FUNCTIONS

### ■ Power save

The power save function reduces the current drain to conserve battery power.

The power save duty cycle, the ratio of receive circuit on to receive circuit off during standby, can be set to automatic (default), 1 : 1 (150 msec. : 150msec.), 1 : 4 (150 msec. : 600msec.), 1 : 8 (150 msec. : 1200msec.) or OFF with “POWER SAVE” in set mode. (p. 88)

⟨MENU screen⟩ ⇨ ⟨SET MODE⟩ ⇨ ⟨POWER SAVE⟩  
(Push [MENU/LOCK]) (Rotate [DIAL]<sup>†</sup>, then push [↵](5)<sup>†</sup>.)

- “AUTO” selects “1:1” duty ratio when receiving no signal for 5 sec., then “1:4” 60 sec. after that. The ratio becomes “1:8” when no signal is received for another 60 sec.

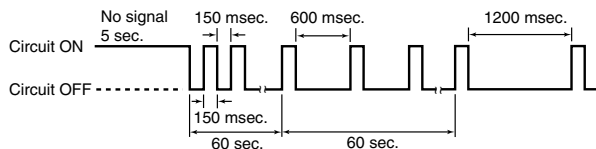

### ■ Auto power OFF

The transceiver can be set to automatically turn OFF after a specified period with a beep when no switch is pushed.

120 min., 90 min., 60 min., 30 min. and OFF can be specified. The specified period is retained even when the transceiver is turned OFF by the auto power-off function. To cancel the function, select “OFF” in the auto power-off item in set mode.

This can be selected with “AP OFF” in set mode. (p. 88)

⟨MENU screen⟩ ⇨ ⟨SET MODE⟩ ⇨ ⟨AP OFF⟩  
(Push [MENU/LOCK]) (Rotate [DIAL]<sup>†</sup>, then push [↵](5)<sup>†</sup>.)

### ■ Auto power ON

The transceiver can be set to automatically turn ON after a specified period. The timer can be selected within 30 min. to 24 hrs. in 30 min. steps.

This can be selected with “AP ON” in set mode. (p. 89)

⟨MENU screen⟩ ⇨ ⟨SET MODE⟩ ⇨ ⟨AP ON⟩  
(Push [MENU/LOCK]) (Rotate [DIAL]<sup>†</sup>, then push [↵](5)<sup>†</sup>.)

- /// When operating with battery pack or case and the battery is exhausted, auto power-on does not function.
- /// A slight current still flows in the circuits during standby condition of the auto power-on function.



## ■ Time-out timer

To prevent accidental prolonged transmission, etc., the transceiver has a time-out timer. This timer cuts a transmission OFF after 1, 3, 5 or 10 min. of continuous transmission. This timer can be cancelled (default).

/// Approx. 10 sec. before the time-out timer is activated, the transceiver emits a beep tone as a warning.

This can be selected with “TOT” in set mode. (p. 90)

◀MENU screen ↔ ▶SET MODE ↔ ▶TOT  
(Push [MENU/LOCK]) (Rotate [DIAL]<sup>†</sup>, then push [↵](5)<sup>†</sup>.)

## ■ PTT lock

To prevent accidental transmission, etc., the transceiver has a PTT lock function.

This can be selected with “PTT LOCK” in set mode. (p. 90)

◀MENU screen ↔ ▶SET MODE ↔ ▶PTT LOCK  
(Push [MENU/LOCK]) (Rotate [DIAL]<sup>†</sup>, then push [↵](5)<sup>†</sup>.)

## ■ [MIC/SP] jacks

To connect external equipment such as speaker, microphone, TNC, etc. refer to the diagram below.

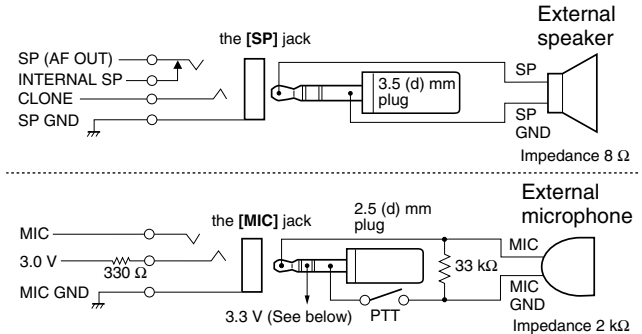

/// The center terminal of [MIC] outputs 3.3 V DC via 330 Ω resistor.

## 12 OTHER FUNCTIONS

### ■ Cloning function

The IC-E91 has transceiver-to-transceiver data cloning capability. This function is useful when you want to copy all of the programmed contents from one IC-E91 to another.

• An optional OPC-474 CLONING CABLE is required.

- ① Turn the transceiver's power OFF, then connect an optional OPC-474 between both [SP] jacks.
- ② While pushing [MR] and [MENU/LOCK], push and hold [PWR] for 1 sec. to enter cloning mode.
  - "CLONE M" appears.
- ③ Push [PTT] on the "master" transceiver.
  - "CLONE OUT M" appears and the bar meter shows that cloning is taking place.
  - After the cloning is completed, the display returns to "CLONE M."
- ④ Push and hold [PWR] for 1 sec. to turn power OFF.

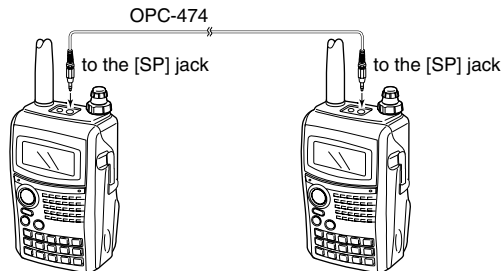

The optional RS-91 REMOTE CONTROL SOFTWARE is also available to clone/edit contents with a PC (for Microsoft® Windows® 98/98SE/ME/2000XP) and using ICF format files.

Microsoft® and Windows® are registered trademarks of Microsoft Corporation in the U.S.A. and other countries.

## ■ Resetting

The function display may occasionally display erroneous information (e.g. when first applying power). This may be caused externally by static electricity or by other factors.

If this problem occurs, turn power OFF. After waiting a few seconds, turn power ON again. If the problem persists, perform either or both procedures below.

### • All reset

Reset the CPU before operating the transceiver for the first time, or if the internal CPU malfunctions, to clear and return all programmed contents to their default settings.

### • Partial reset

If you want to initialize the operating conditions (VFO frequency, VFO settings, set mode contents) without clearing the memory contents, a partial reset function is available for the transceiver.

### ◇ All reset

- ① Push and hold [PWR] for 1 sec. to turn power OFF.
- ② While pushing and holding [VFO], [MR] and [BAND], then turn power ON to reset the CPU.
  - “ALL RESET” appears when resetting the CPU (See the illustration below).

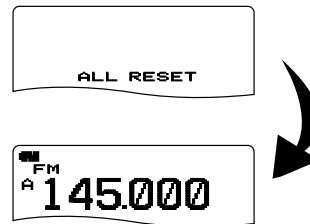

**CAUTION:** Resetting the CPU returns all programmed contents to their default settings.

### ◇ Partial reset

- ① Push and hold [PWR] for 1 sec. to turn power OFF.
- ② While pushing and holding [VFO], then turn power ON to partially reset the transceiver.

**[NOTE]:** No message appears on the display after the partial reset is done.

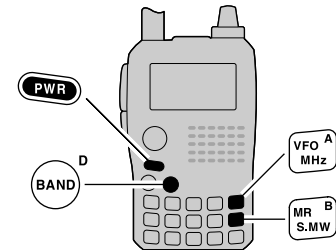

# 13 TROUBLESHOOTING

If your transceiver seems to be malfunctioning, please check the following points before sending it to a service center.

PROBLEM	POSSIBLE CAUSE	SOLUTION	REF.
No power comes ON.	<ul style="list-style-type: none"> <li>• The batteries are exhausted.</li> <li>• The battery polarity is reversed.</li> </ul>	<ul style="list-style-type: none"> <li>• Replace the batteries or charge the battery pack.</li> <li>• Check the battery polarity.</li> </ul>	pgs. 1, 10–12 p. 12
No sound comes from the speaker.	<ul style="list-style-type: none"> <li>• Volume level is too low.</li> <li>• Different tone is selected with tone/DTCS squelch.</li> </ul>	<ul style="list-style-type: none"> <li>• Rotate <b>[VOL]</b> to suitable level.</li> <li>• Check the tone using tone/DTCS scan.</li> </ul>	p. 20 p. 112
Transmitting is impossible.	<ul style="list-style-type: none"> <li>• The batteries are exhausted.</li> <li>• A frequency outside of the 144/430 MHz amateur bands is set.</li> </ul>	<ul style="list-style-type: none"> <li>• Replace the batteries or charge the battery pack.</li> <li>• Reset the frequency within 144/430 MHz amateur bands.</li> </ul>	pgs. 1, 10–12 p. 24
No contact possible with another station.	<ul style="list-style-type: none"> <li>• Different tone is selected with tone/DTCS squelch.</li> </ul>	<ul style="list-style-type: none"> <li>• Check the tone/DTCS using tone scan.</li> </ul>	p. 112
Frequency can not be set.	<ul style="list-style-type: none"> <li>• The lock function is activated.</li> <li>• Memory mode or call channel is selected.</li> </ul>	<ul style="list-style-type: none"> <li>• Push <b>[MENU/LOCK]</b> for 1 sec. to cancel the function.</li> <li>• Push <b>[VFO]</b> to set VFO mode.</li> </ul>	p. 25 p. 15
Program scan function can not start.	<ul style="list-style-type: none"> <li>• Memory mode or call channel is selected.</li> <li>• Same frequencies are programmed both <b>*A</b> and <b>*B</b> of PROGRAM-CH.</li> </ul>	<ul style="list-style-type: none"> <li>• Push <b>[VFO]</b> to set VFO mode.</li> <li>• Programming different frequencies in <b>*A</b> and <b>*B</b> respectively.</li> </ul>	p. 15 p. 74
Memory scan function can not start.	<ul style="list-style-type: none"> <li>• VFO mode or call channel is selected.</li> <li>• The programmed memory channel is only one.</li> </ul>	<ul style="list-style-type: none"> <li>• Push <b>[MR]</b> to set memory mode.</li> <li>• Program more than 2 memory channels.</li> </ul>	p. 15 p. 66
The displayed frequency is erroneous.	<ul style="list-style-type: none"> <li>• The CPU malfunctioned.</li> <li>• External factors caused a fault.</li> </ul>	<ul style="list-style-type: none"> <li>• Reset the transceiver.</li> <li>• Remove and re-attach the battery pack or battery case.</li> </ul>	p. 117 p. 1
Can not charge the battery with BC-139 (LED blinks orange).	<ul style="list-style-type: none"> <li>• Turn the transceiver's power ON.</li> </ul>	<ul style="list-style-type: none"> <li>• Turn the transceiver's power OFF, or insert only the battery pack into the BC-139 to charge it.</li> </ul>	pgs. 11 ,20

## ◇ General

- Frequency coverage\* : (unit: MHz)

Version	A band	B band
<b>Europe, U.K.</b>	Tx: 144–146, 430–440 Rx: 0.495–999.990	Tx: 144–146, 430–440 Rx: 118–174, 350–470
<b>Italy</b>	Tx: 144–146, 430–434, 435–438 Rx: 0.495–29.995, 50–51, 76–136.995, 144–146, 430–434, 435–438	Tx: 144–146, 430–434, 435–438 Rx: 118–136.995, 144–146, 430–434, 435–438
<b>France</b>	Tx: 144–146, 430–440 Rx: 0.495–29.995, 50–52, 76–136.995, 144–146, 430–440	Tx: 144–146, 430–440 Rx: 118–136.995, 144–146, 430–440

\*Specifications guaranteed for 144–148 MHz and 430–440 MHz ranges only.

- Mode : FM, AM (Rx only), WFM (Rx only), DV<sup>†</sup>
- No. of memory channels : 1304  
(incl. 100 scan edges and 4 call channels)
- Usable temp. range : –20°C to +60°C
- Tuning steps : 5<sup>‡</sup>, 6.25<sup>‡</sup>, 8.33<sup>‡</sup>, 9<sup>‡</sup>, 10, 12.5, 15, 20, 25, 30, 50, 100, 125 and 200 kHz
- Frequency stability : ±2.5 ppm (–20°C to +60°C)
- Power supply : 10.0–16.0 V DC for external DC power, or specified Icom's battery pack
- Digital transmission speed: 4.8 kbps<sup>†</sup>
- Voice coding speed : 2.4 kbps<sup>†</sup>
- Current drain (at 7.4 V DC) :
  - Tx High 144 MHz 2.1 A typical
  - 430 MHz 2.2 A typical
  - Tx Low 0.8 A (approx.)
  - Rx max. power 340 mA typical (dualwatch; FM/DV<sup>†</sup>)
  - standby 170 mA typical (dualwatch; FM/DV<sup>†</sup>)

- Antenna connector : SMA (50 Ω)
- Dimensions : 58.4(W)×103(H)×34.2(D) mm  
(projections not included)
- Weight (approx.) : 300 g (with antenna and BP-217)
- Data connector : 3-conductor 2.5 (d) mm

## ◇ Transmitter

- Modulation system :
  - FM Variable reactance freq. modulation
  - DV (Digital)<sup>†</sup> GMSK reactance freq. modulation
- Output power (at 7.4 V DC) : High 5.0 W, Low 0.5 W (approx.)
- Max. frequency deviation : ±5.0 kHz (FM wide: approx.)  
±2.5 kHz (FM narrow: approx.)
- Spurious emissions : Less than –60 dB
- Ext. mic. connector : 3-conductor 2.5 (d) mm; (1/10<sup>–7</sup>)/2 kΩ

<sup>†</sup>Available when UT-121 is installed.

<sup>‡</sup>Selectable depending on the operating frequency band.

# 14 SPECIFICATIONS

## ◇ Receiver

- Receive system :
  - FM/AM Double-conversion superheterodyne
  - WFM Triple-conversion superheterodyne
- Intermediate frequencies :
  - 1st A band 61.65 MHz/59.25 MHz (WFM)
  - B band 46.35 MHz
  - 2nd 450 kHz/13.35 MHz (WFM)
  - 3rd 1.95 MHz (WFM only)
- Sensitivity (except spurious points):
  - AM (1 kHz/30% Mod.; 10 dB S/N)
    - 0.495–4.995 MHz 1.3  $\mu$ V typ.
    - 5.000–29.995 MHz 0.56  $\mu$ V typ.
    - 118.000–137.000 MHz 0.5  $\mu$ V typ.
    - 222.000–246.995 MHz 0.79  $\mu$ V typ.
    - 247.000–329.995 MHz 1  $\mu$ V typ.
  - FM (1 kHz/3.5 kHz Dev.; 12 dB SINAD)
    - VHF (Amateur band only) 0.14  $\mu$ V typ.
    - UHF (Amateur band only) 0.16  $\mu$ V typ.
    - 1.625–29.995 MHz 0.4  $\mu$ V typ.
    - 30.000–117.995 MHz 0.25  $\mu$ V typ.
    - 118.000–173.995 MHz 0.18  $\mu$ V typ.
    - 174.000–349.995 MHz 0.32  $\mu$ V typ.
    - 350.000–469.995 MHz 0.22  $\mu$ V typ.
    - 470.000–599.995 MHz 0.32  $\mu$ V typ.
    - 600.000–999.990 MHz 0.56  $\mu$ V typ.
  - WFM (1 kHz/52.5 kHz Dev.; 12 dB SINAD)
    - 76.000–108.000 MHz 1  $\mu$ V typ.
    - 175.000–221.995 MHz 1.8  $\mu$ V typ.
    - 470.000–770.000 MHz 2.5  $\mu$ V typ.
  - DV (digital/PN9 4.8 kbps; BER 1%)<sup>†</sup>
    - Amateur bands 0.22  $\mu$ V typ.
- Selectivity :
  - FM (Wide), AM More than 50 dB
  - FM (Narrow), DV<sup>†</sup> More than 45 dB
  - WFM More than 300 kHz/–3 dB
  - Less than 700 kHz/–20 dB
- Spurious and image rejection ratio:
  - VHF More than 60 dB
  - UHF More than 50 dB
  - (Intermediate freq.; More than 60 dB)
- Audio output power : More than 200 mW at 10% distortion with an 8  $\Omega$  load
- Ext. speaker connector : 3-conductor 3.5(d) mm; (1/8")/8  $\Omega$

<sup>†</sup>Available when UT-121 is installed.

- **UT-121** DIGITAL UNIT  
Provides DV mode operation for IC-E91.
- **RS-91** REMOTE CONTROL SOFTWARE  
Allows you to operate the transceiver, as well as the easy memory management from the connected PC for Microsoft® Windows® 98/98SE/ME/2000/XP with an RS-232C (COM) port. In addition, low-speed data communication is enabled with this software for DV mode operation. A data communication cable, OPC-1529R, is supplied with the software.
- **BC-139** DESKTOP CHARGER  
Rapidly charges BP-217 Li-ion battery pack in 2.5 hrs.
- **BP-216** BATTERY CASE  
Battery case for R6 (AA) × 2 alkaline batteries.
- **BP-217** LI-ION BATTERY PACK  
7.4 V/1300 mAh Lithium Ion battery pack. Battery life: 5 hrs. (approx.; VHF, FM, high power, Tx : Rx : Standby = 1:1:8)
- **HM-75A** REMOTE CONTROL MICROPHONE  
Allows you to remotely select operating channels, etc.
- **HM-131** SPEAKER-MICROPHONE  
For operation while conveniently hanging the transceiver from your belt, etc.
- **HM-128/HM-153** EARPHONE-MICROPHONE  
Ideal for hands-free operation by clipping the microphone with the PTT switch to your lapel or breast pocket.
- **HS-85** HEADSET WITH VOX/PTT UNIT  
Hands-free headset with VOX control box.
- **CP-19R** CIGARETTE LIGHTER CABLE WITH DC-DC CONVERTER  
Allows you to operate the transceiver through a 12 V cigarette lighter socket, and also charge the attached battery pack (during stand-by only) regularly. A built-in DC-DC converter outputs 11 V DC.
- **OPC-254L** DC POWER CABLE  
For operation and charging via an external power supply.
- **OPC-474** CLONING CABLE  
Used for handheld-to-handheld cloning.
- **OPC-1529R** DATA COMMUNICATION CABLE  
Allows you to GPS operation in DV mode operation.
- **SP-13** EARPHONE  
Provides clear receive audio in noisy environments.
- **LC-163** CARRYING CASE  
Helps protect the transceiver from scratches, etc.
- **AD-92SMA** ANTENNA CONNECTOR ADAPTER  
Allows you to connect an external antenna with a BNC connector.

Microsoft® and Windows® are registered trademarks of Microsoft Corporation in the U.S.A. and other countries.

## ■ Optional UT-121 installation

### RECOMMENDATION:

Critical technique is necessary for the UT-121 installation, therefore, we recommend you to install it at your dealer or service center.

The optional UT-121 is installed inside the unit holder which is located under the battery pack/case's space. Install the optional UT-121 as following procedures.

- ① Unscrew 2 screws to remove the unit cover.

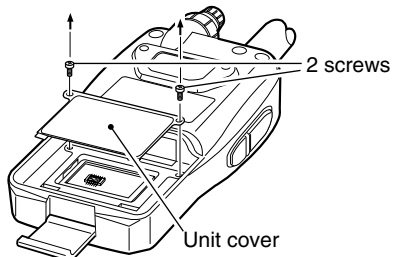

- ② Insert the UT-121's fixed part to the unit holder (1), then take down it to the unit holder (2) as the right illustration.

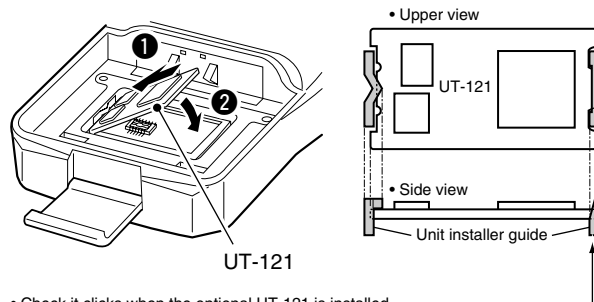

- Check it clicks when the optional UT-121 is installed.
- Check the optional UT-121 is locked to the unit installer guide.

- ④ Check the UT-121 position where is located under the transceiver's chassis.
- ⑤ Push both edges of the UT-121 to install it into the transceiver, then confirm to install it completely.
- ⑥ Screw 2 screws to assemble the unit cover.

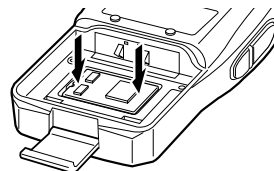



## ■ Optional HM-75A REMOTE CONTROL MICROPHONE

The optional HM-75A allows you to remotely select operating frequencies, memory channels, etc.

Remote control functions can be selected from 3 settings. These can be selected with “MIC SIMPLE MODE” in set mode. (p. 89)

◀MENU screen▶ ⇄ ▶SET MODE▶ ⇄ ▶MIC SIMPLE MODE▶  
 (Push [MENU/LOCK]) (Rotate [DIAL]†, then push [↵](5)†.)

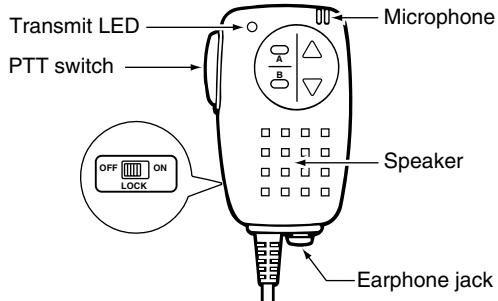

The HM-75A has a lock switch on the backside to prevent accidental frequency changes, etc.

⚡ Be sure to turn power OFF when plugging the HM-75A to the [MIC/SP] jacks.

†[DIAL] ↔ [▲](2)/[▼](8)

[↵](5) ↔ [▶](6)

### • NORM-1: (default)

[A]	Selects band.
[B]	Toggles VFO mode and memory mode.
[▲]	Frequency or memory channel “UP”.
[▼]	Frequency or memory channel “DOWN”.

### • NORM-2:

[A]	Toggles the monitor function.
[B]	Toggles VFO mode and memory mode.
[▲]	Frequency or memory channel “UP”.
[▼]	Frequency or memory channel “DOWN”.

### • SIMPLE:

[A]	Toggles the monitor function.
[B]	Selects call channel C0.
[▲]	<ul style="list-style-type: none"> <li>• Selects memory channel 000 in memory mode.</li> <li>• Volume “UP” while operating the monitor function.</li> </ul>
[▼]	<ul style="list-style-type: none"> <li>• Selects memory channel 001 in memory mode.</li> <li>• Volume “DOWN” while operating the monitor function.</li> </ul>

⚡ VFO mode cannot be selected via the microphone when SIMPLE mode is selected.

⚡ SIMPLE mode can select only 3 channels and is useful for group operations during touring, etc.

---

## INSTALLATION NOTES

---

- When transmitting with a portable radio, hold the radio in a vertical position with its microphone 2.5 to 5 centimeters away from your mouth. Keep antenna at least 2.5 centimeters from your head and body.
- If you wear a portable two-way radio on your body, ensure that the antenna is at least 2.5 centimeters from your body when transmitting.



Versions of the IC-E91 which display the “CE” symbol on the serial number seal, comply with the essential requirements of the European Radio and Telecommunication Terminal Directive 1999/5/EC.



This warning symbol indicates that this equipment operates in non-harmonised frequency bands and/or may be subject to licensing conditions in the country of use. Be sure to check that you have the correct version of this radio or the correct programming of this radio, to comply with national licensing requirement.



## DECLARATION OF CONFORMITY

We Icom Inc. Japan

1-1-32, Kamiminami, Hirano-ku  
Osaka 547-0003, Japan

Declare on our sole responsibility that this equipment complies with the essential requirements of the Radio and Telecommunications Terminal Equipment Directive, 1999/5/EC, and that any applicable Essential Test Suite measurements have been performed.

**Kind of equipment:** VHF/UHF FM TRANSCEIVER

**Type-designation:** IC-E91

**Version (where applicable):** \_\_\_\_\_

This compliance is based on conformity with the following harmonised standards, specifications or documents:

- i) EN 301 489-1
- ii) EN 301 489-15 Article 3.1b
- iii) EN 301 783-2 Article 3.2
- iv) EN 60950-1: 2001
- v) \_\_\_\_\_



Düsseldorf 21st Apr. 2006  
Place and date of issue

Icom (Europe) GmbH  
Himmelgeister straÙe 100  
D-40225 Düsseldorf

Authorized representative name  
H. Ikegami  
General Manager

Signature

**Icom Inc.**

## Count on us!

#22 Europe

<Intended Country of Use>			
<input checked="" type="checkbox"/> GER	<input type="checkbox"/> FRA	<input checked="" type="checkbox"/> ESP	<input checked="" type="checkbox"/> SWE
<input checked="" type="checkbox"/> AUT	<input checked="" type="checkbox"/> NED	<input checked="" type="checkbox"/> POR	<input checked="" type="checkbox"/> DEN
<input type="checkbox"/> GBR	<input checked="" type="checkbox"/> BEL	<input checked="" type="checkbox"/> ITA	<input checked="" type="checkbox"/> FIN
<input checked="" type="checkbox"/> IRL	<input checked="" type="checkbox"/> LUX	<input checked="" type="checkbox"/> GRE	<input type="checkbox"/> SUI
<input type="checkbox"/> NOR			

#23 UK

<Intended Country of Use>			
<input type="checkbox"/> GER	<input type="checkbox"/> FRA	<input type="checkbox"/> ESP	<input type="checkbox"/> SWE
<input type="checkbox"/> AUT	<input type="checkbox"/> NED	<input type="checkbox"/> POR	<input type="checkbox"/> DEN
<input checked="" type="checkbox"/> GBR	<input type="checkbox"/> BEL	<input type="checkbox"/> ITA	<input type="checkbox"/> FIN
<input type="checkbox"/> IRL	<input type="checkbox"/> LUX	<input type="checkbox"/> GRE	<input type="checkbox"/> SUI
<input type="checkbox"/> NOR			

#24 Italy

<Intended Country of Use>			
<input type="checkbox"/> GER	<input type="checkbox"/> FRA	<input type="checkbox"/> ESP	<input type="checkbox"/> SWE
<input type="checkbox"/> AUT	<input type="checkbox"/> NED	<input type="checkbox"/> POR	<input type="checkbox"/> DEN
<input type="checkbox"/> GBR	<input type="checkbox"/> BEL	<input checked="" type="checkbox"/> ITA	<input type="checkbox"/> FIN
<input type="checkbox"/> IRL	<input type="checkbox"/> LUX	<input type="checkbox"/> GRE	<input type="checkbox"/> SUI
<input type="checkbox"/> NOR			

#30 France

<Intended Country of Use>			
<input type="checkbox"/> GER	<input checked="" type="checkbox"/> FRA	<input type="checkbox"/> ESP	<input type="checkbox"/> SWE
<input type="checkbox"/> AUT	<input type="checkbox"/> NED	<input type="checkbox"/> POR	<input type="checkbox"/> DEN
<input type="checkbox"/> GBR	<input type="checkbox"/> BEL	<input type="checkbox"/> ITA	<input type="checkbox"/> FIN
<input type="checkbox"/> IRL	<input type="checkbox"/> LUX	<input type="checkbox"/> GRE	<input type="checkbox"/> SUI
<input type="checkbox"/> NOR			